

# 4K HDR Multi-Channel to Two-Channel Audio Converter



## Version Information

---

Version	Release Date	Notes
1	04/17	Initial release
2	09/18	1.1.22 firmware updates: <ul style="list-style-type: none"><li>• Front-panel button factory-reset functionality.</li><li>• Added HDMI OUT and HDMI PCM EDID settings.</li></ul>

## Welcome to Atlona!

---

Thank you for purchasing this Atlona product. We hope you enjoy it and will take a extra few moments to register your new purchase.

Registration only takes a few minutes and protects this product against theft or loss. In addition, you will receive notifications of product updates and firmware. Atlona product registration is voluntary and failure to register will not affect the product warranty.

To register your product, go to <http://www.atlona.com/registration>

## Sales, Marketing, and Customer Support

---

### Main Office

Atlona Incorporated  
70 Daggett Drive  
San Jose, CA 95134  
United States

Office: +1.877.536.3976 (US Toll-free)  
Office: +1.408.962.0515 (US/International)

Sales and Customer Service Hours  
Monday - Friday: 6:00 a.m. - 4:30 p.m. (PST)

<http://www.atlona.com/>

### International Headquarters

Atlona International AG  
Ringstrasse 15a  
8600 Dübendorf  
Switzerland

Office: +41 43 508 4321

Sales and Customer Service Hours  
Monday - Friday: 09:00 - 17:00 (UTC +1)

## Operating Notes

---



**IMPORTANT:** Visit <http://www.atlona.com/product/AT-HDR-M2C> for the latest firmware updates and User Manual.

# Atlona, Inc. (“Atlona”) Limited Product Warranty

---

## Coverage

Atlona warrants its products will substantially perform to their published specifications and will be free from defects in materials and workmanship under normal use, conditions and service.

Under its Limited Product Warranty, Atlona, at its sole discretion, will either:

- repair or facilitate the repair of defective products within a reasonable period of time, restore products to their proper operating condition and return defective products free of any charge for necessary parts, labor and shipping.

OR

- replace and return, free of charge, any defective products with direct replacement or with similar products deemed by Atlona to perform substantially the same function as the original products.

OR

- refund the pro-rated value based on the remaining term of the warranty period, not to exceed MSRP, in cases where products are beyond repair and/or no direct or substantially similar replacement products exist.

Repair, replacement or refund of Atlona products is the purchaser’s exclusive remedy and Atlona liability does not extend to any other damages, incidental, consequential or otherwise.

This Limited Product Warranty extends to the original end-user purchaser of Atlona products and is non-transferrable to any subsequent purchaser(s) or owner(s) of these products.

## Coverage Periods

Atlona Limited Product Warranty Period begins on the date of purchase by the end-purchaser. The date contained on the end-purchaser’s sales or delivery receipt is the proof purchase date.

### Limited Product Warranty Terms – New Products

- 10 years from proof of purchase date for hardware/electronics products purchased on or after June 1, 2013.
- 3 years from proof of purchase date for hardware/electronics products purchased before June 1, 2013.
- Lifetime Limited Product Warranty for all cable products.

### Limited Product Warranty Terms – Refurbished (B-Stock) Products and Discontinued Products

- 3 years from proof of purchase date for all Refurbished (B-Stock) and Discontinued hardware and electronic products purchased on or after June 1, 2013.

## Remedy

Atlona recommends that end-purchasers contact their authorized Atlona dealer or reseller from whom they purchased their products. Atlona can also be contacted directly. Visit [atlona.com](http://atlona.com) for Atlona’s contact information and hours of operation. Atlona requires that a dated sales or delivery receipt from an authorized dealer, reseller or end-purchaser is provided before Atlona extends its warranty services. Additionally, a return merchandise authorization (RMA) and/or case number, is required to be obtained from Atlona in advance of returns.

Atlona requires that products returned are properly packed, preferably in the original carton, for shipping. Cartons not bearing a return authorization or case number will be refused. Atlona, at its sole discretion, reserves the right to reject any products received without advanced authorization. Authorizations can be requested by calling 1-877-536-3976 (US toll free) or 1-408- 962-0515 (US/international) or via Atlona’s website at [atlona.com](http://atlona.com).

## Exclusions

This Limited Product Warranty excludes:

- Damage, deterioration or malfunction caused by any alteration, modification, improper use, neglect, improper packaging or shipping (such claims must be presented to the carrier), lightning, power surges, or other acts of nature.

## Atlona, Inc. (“Atlona”) Limited Product Warranty

---

- Damage, deterioration or malfunction resulting from the installation or removal of this product from any installation, any unauthorized tampering with this product, any repairs attempted by anyone unauthorized by Atlona to make such repairs, or any other cause which does not relate directly to a defect in materials and/or workmanship of this product.
- Equipment enclosures, cables, power supplies, batteries, LCD displays, and any accessories used in conjunction with the product(s).
- Products purchased from unauthorized distributors, dealers, resellers, auction websites and similar unauthorized channels of distribution.

### Disclaimers

This Limited Product Warranty does not imply that the electronic components contained within Atlona’s products will not become obsolete nor does it imply Atlona products or their electronic components will remain compatible with any other current product, technology or any future products or technologies in which Atlona’s products may be used in conjunction with. Atlona, at its sole discretion, reserves the right not to extend its warranty offering in instances arising outside its normal course of business including, but not limited to, damage inflicted to its products from acts of god.

### Limitation on Liability

The maximum liability of Atlona under this limited product warranty shall not exceed the original Atlona MSRP for its products. To the maximum extent permitted by law, Atlona is not responsible for the direct, special, incidental or consequential damages resulting from any breach of warranty or condition, or under any other legal theory. Some countries, districts or states do not allow the exclusion or limitation of relief, special, incidental, consequential or indirect damages, or the limitation of liability to specified amounts, so the above limitations or exclusions may not apply to you.

### Exclusive Remedy

To the maximum extent permitted by law, this limited product warranty and the remedies set forth above are exclusive and in lieu of all other warranties, remedies and conditions, whether oral or written, express or implied. To the maximum extent permitted by law, Atlona specifically disclaims all implied warranties, including, without limitation, warranties of merchantability and fitness for a particular purpose. If Atlona cannot lawfully disclaim or exclude implied warranties under applicable law, then all implied warranties covering its products including warranties of merchantability and fitness for a particular purpose, shall provide to its products under applicable law. If any product to which this limited warranty applies is a “Consumer Product” under the Magnuson-Moss Warranty Act (15 U.S.C.A. §2301, ET SEQ.) or other applicable law, the foregoing disclaimer of implied warranties shall not apply, and all implied warranties on its products, including warranties of merchantability and fitness for the particular purpose, shall apply as provided under applicable law.

### Other Conditions

Atlona’s Limited Product Warranty offering gives legal rights, and other rights may apply and vary from country to country or state to state. This limited warranty is void if (i) the label bearing the serial number of products have been removed or defaced, (ii) products are not purchased from an authorized Atlona dealer or reseller. A comprehensive list of Atlona’s authorized distributors, dealers and resellers can be found at [www.atlona.com](http://www.atlona.com).

## Safety and Certification

**CAUTION**  
 RISK OF ELECTRIC SHOCK  
 DO NOT OPEN

CAUTION: TO REDUCE THE RISK OF ELECTRIC SHOCK DO NOT OPEN ENCLOSURE OR EXPOSE TO RAIN OR MOISTURE. NO USER-SERVICEABLE PARTS INSIDE REFER SERVICING TO QUALIFIED SERVICE PERSONNEL.



The exclamation point within an equilateral triangle is intended to alert the user to the presence of important operating and maintenance instructions in the literature accompanying the product.



The information bubble is intended to alert the user to helpful or optional operational instructions in the literature accompanying the product.

1. Read these instructions.
2. Keep these instructions.
3. Heed all warnings.
4. Follow all instructions.
5. Do not use this product near water.
6. Clean only with a dry cloth.
7. Do not block any ventilation openings. Install in accordance with the manufacturer's instructions.
8. Do not install or place this product near any heat sources such as radiators, heat registers, stoves, or other apparatus (including amplifiers) that produce heat.
9. Do not defeat the safety purpose of a polarized or grounding-type plug. A polarized plug has two blades with one wider than the other. A grounding type plug has two blades and a third grounding prong. The wide blade or the third prong are provided for your safety. If the provided plug does not fit into your outlet, consult an electrician for replacement of the obsolete outlet.
10. Protect the power cord from being walked on or pinched particularly at plugs, convenience receptacles, and the point where they exit from the product.
11. Only use attachments/accessories specified by Atlona.
12. To reduce the risk of electric shock and/or damage to this product, never handle or touch this unit or power cord if your hands are wet or damp. Do not expose this product to rain or moisture.
13. Unplug this product during lightning storms or when unused for long periods of time.
14. Refer all servicing to qualified service personnel. Servicing is required when the product has been damaged in any way, such as power-supply cord or plug is damaged, liquid has been spilled or objects have fallen into the product, the product has been exposed to rain or moisture, does not operate normally, or has been dropped.



## FCC Statement

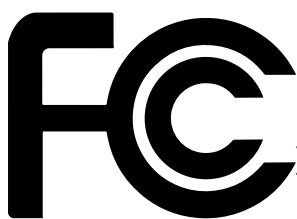

FCC Compliance and Advisory Statement: This hardware device complies with Part 15 of the FCC rules. Operation is subject to the following two conditions: 1) this device may not cause harmful interference, and 2) this device must accept any interference received including interference that may cause undesired operation. This equipment has been tested and found to comply with the limits for a Class A digital device, pursuant to Part 15 of the FCC Rules.

These limits are designed to provide reasonable protection against harmful interference in a commercial installation. This equipment generates, uses, and can radiate radio frequency energy and, if not installed or used in accordance with the instructions, may cause harmful interference to radio communications. However there is no guarantee that interference will not occur in a particular installation. If this equipment does cause harmful interference to radio or television reception, which can be determined by turning the equipment off and on, the user is encouraged to try to correct the interference by one or more of the following measures: 1) reorient or relocate the receiving antenna; 2) increase the separation between the equipment and the receiver; 3) connect the equipment to an outlet on a circuit different from that to which the receiver is connected; 4) consult the dealer or an experienced radio/TV technician for help. Any changes or modifications not expressly approved by the party responsible for compliance could void the user's authority to operate the equipment. Where shielded interface cables have been provided with the product or specified additional components or accessories elsewhere defined to be used with the installation of the product, they must be used in order to ensure compliance with FCC regulations.



The terms HDMI, HDMI High-Definition Multimedia Interface, and the HDMI Logo are trademarks or registered trademarks of HDMI licensing Administrator, Inc.

# Table of Contents

---

<b>Introduction</b>	<b>8</b>
<b>Features</b>	<b>8</b>
<b>Package Contents</b>	<b>8</b>
<b>Panel Description</b>	<b>9</b>
<b>Installation</b>	<b>10</b>
Audio Connector	10
Power Connector	10
Connection Instructions	11
Connection Diagram	12
<b>Basic Operation</b>	<b>13</b>
LED Indicators	13
Audio Input Indicators	13
Front-Panel Button	14
Toggling the IP Mode	14
Resetting to Factory-Defaults	14
EDID Management	15
Loading EDID Presets	15
Copying a Downstream EDID	16
<b>The WebGUI</b>	<b>17</b>
Introduction to the webGUI	17
Menu Bar	18
Toggles	19
Sliders	19
Buttons	19
Info page	20
System Info	20
Video Info	20
Audio Info	21
A/V Settings page	22
Video	22
Audio	22
Config page	23
Configuration	23
System page	24
Network	24
System	25
<b>Appendix</b>	<b>26</b>
Updating the Firmware	26
Using the Web GUI	26
Using USB	27
Mounting Instructions	29
Default Settings	30
Specifications	31
<b>Index</b>	<b>33</b>

## Introduction

---

The Atlona **AT-HDR-M2C** is an audio converter for extracting and downmixing multi-channel PCM, Dolby®, and DTS® audio from HDMI® sources. It features an HDMI input with pass-through, and delivers stereo downmixed audio over a separate HDMI output, as well as unbalanced analog and TOSLINK digital audio outputs. The HDR-M2C is compatible with high dynamic range (HDR) formats and is HDCP 2.2 compliant. It supports 4K/UHD video @ 60 Hz with 4:4:4 chroma sampling, as well as HDMI data rates up to 18 Gbps. This audio converter includes EDID management features as well as audio volume and bass / treble controls, all available via Ethernet through the Atlona Management System (AMS), the web GUI, or a control system. The HDR-M2C can conveniently serve surround sound and two-channel audio systems from a multi-channel audio source.

The HDR-M2C is ideal for residential and commercial applications with the latest as well as emerging 4K/UHD and HDR sources and displays. It is compatible with all video resolutions, audio formats, and color space formats supported in the HDMI 2.0a specification, plus the ability to pass metadata for HDR content. The HDR-M2C includes Atlona's award-winning 10-year limited product warranty and customer support services, so that integrators can specify, purchase, and install with confidence.

## Features

---

- Downmixes multichannel audio to two-channel audio
- Supports PCM, Dolby Digital, Dolby Digital Plus™, Dolby TrueHD, DTS Digital Surround™, DTS-HD Master Audio™, and DTS:X™
- LED indicators provide power status and audio format identification
- Compatibility with new and emerging 4K/UHD and HDR-capable sources and displays
- Adjustment of output volume, plus bass and treble settings via AMS and the web GUI
- Manages EDID communications with the source through a display's EDID or internally stored EDID

## Package Contents

---

- 1 x AT-HDR-M2C
- 1 x Phoenix terminal block, 3-pin
- 1 x Phoenix terminal block, 2-pin
- 1 x 5V DC power supply
- 1 x Wall/table mounting brackets
- 1 x Installation Guide



## Panel Description

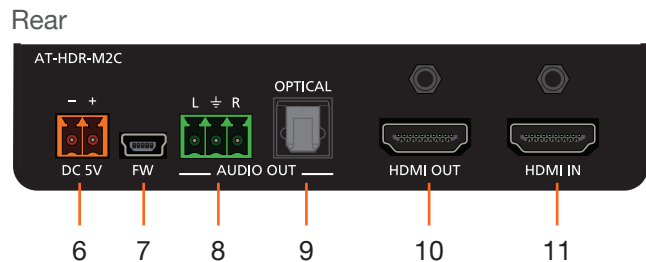
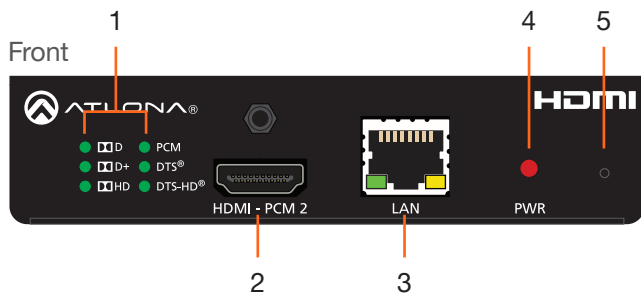

### 1 Audio Indicators

These LED indicators will glow green to indicate the current audio format of the input signal.

### 2 HDMI - PCM 2

Connect an HDMI cable from this port to an HDMI display, extender, or switcher. This output only supports two-channel audio.

### 3 LAN

Connect an Ethernet cable from this port to a Local Area Network (LAN). This port provides access to the web GUI.

### 4 PWR

This LED indicator will glow red when the unit is powered.

### 5 Front Panel Button

This button serves two functions: 1) toggling between static IP and DHCP mode and 2) resetting the unit to factory-default settings. Refer to [Front-Panel Button \(page 14\)](#) for more information.

### 6 DC 5V

Connect the included 5V DC power supply to this power receptacle.

### 7 FW

Connect a mini USB type-B cable to this port to update the firmware.

### 8 L/R

Connect the included 3-pin Phoenix connector from this port to a two-channel audio output device.

### 9 OPTICAL

Connect an optical audio cable from this TOSLINK port to an audio output device. This output only supports two-channel audio.

### 10 HDMI OUT

Connect an HDMI cable from this port to a display or other sink device. This output supports multichannel audio.

### 11 HDMI IN

Connect an HDMI cable from the source to this port.

# Installation

## Audio Connector

The AT-HDR-M2C provides analog audio output of two-channel audio, using the included 3-pin Phoenix terminal block.

1. Use wire strippers to remove a portion of the cable jacket.
2. Remove at least 3/16" (5 mm) from the insulation of each wire.
3. Insert the wires into the correct terminal on the included Phoenix block, as shown below.
4. Tighten the screws to secure the wires. Do not use high-torque devices as this may damage the screws and/or connector block.

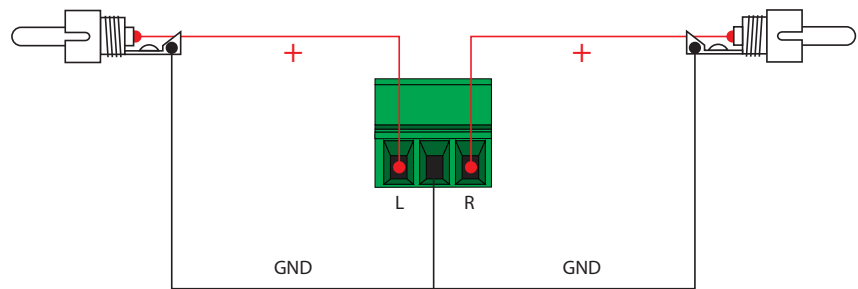
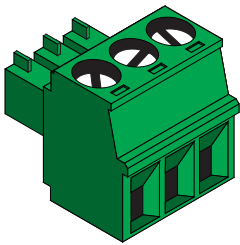

## Power Connector

Locate the included orange Phoenix terminal block and wire the included power supply to the block, as shown below. Do not use high-torque devices, when securing the wires to the Phoenix terminal block, as this may damage the screws and/or block.

1. Insert the wires into the correct terminal on the included Phoenix block, as shown below.
2. Tighten the screws to secure the wires. Do not use high-torque devices as this may damage the screws and/or connector block.

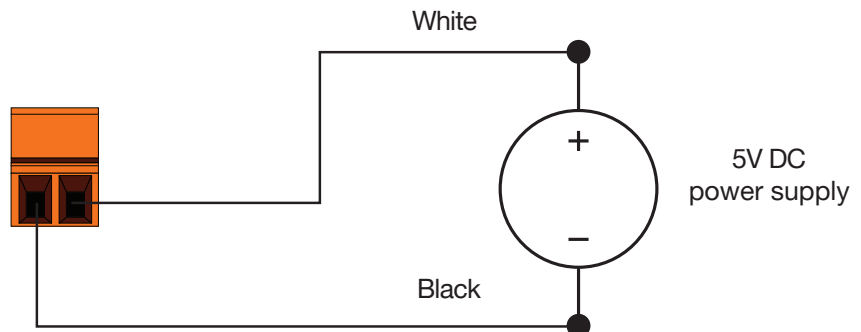
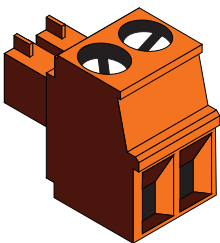

## Connection Instructions

1. Connect an HDMI cable from the UHD/HD source to the **HDMI IN** port on the AT-HDR-M2C.
2. Connect HDMI cables to the output ports:
  - **Multichannel Audio**  
Connect an HDMI cable from the **HDMI OUT** port, on the AT-HDR-M2C, to an AV receiver or other multichannel audio device.
  - **Two-channel audio**  
Connect an HDMI cable from the **HDMI - PCM 2** port, on the AT-HDR-M2C, to a display or other sink device. Audio output is limited to two-channels.
-  **IMPORTANT:** The AT-HDR-M2C is a High Dynamic Range (HDR) device. For best performance, use premium HDMI cables that are HDR-certified.
3. Connect an optical audio cable from the **OPTICAL** port, on the AT-HDR-M2C, to a soundbar or other audio output device. Audio output is limited to two-channels.
4. Connect an Ethernet cable from the **LAN** port on the AT-HDR-M2C, to the Local Area Network (LAN).
5. Connect the green Phoenix block to the **AUDIO OUT** connector.
6. Connect the orange Phoenix block to the **DC 5V** connector.
7. Connect the 5V DC power supply to an available AC outlet.



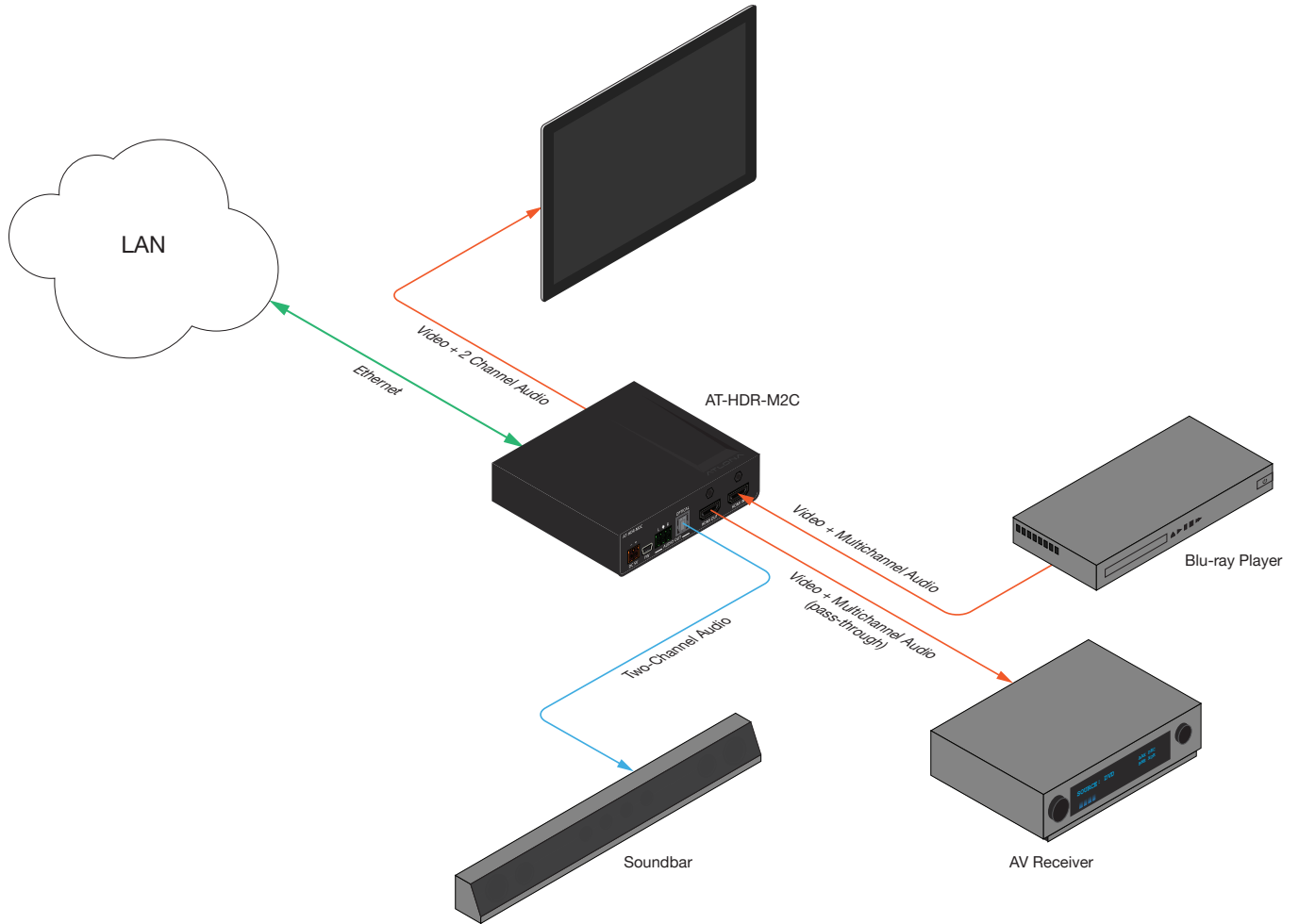

### Connection Diagram



## Basic Operation

### LED Indicators

The following table provides a listing of front-panel LED indicators and their status:



LED		Description
PWR	Off 	<ul style="list-style-type: none"> <li>Unit is powered off.</li> <li>Connect the included 5 V DC power supply to the AT-HDR-M2C. Make sure all connections are secure.</li> <li>Check the electrical outlet and make sure that it is not operated by a wall-switch, which can cut power to the outlet.</li> </ul>
	Red 	<ul style="list-style-type: none"> <li>The AT-HDR-M2C is powered.</li> </ul>
AUDIO FORMATS	Off 	<ul style="list-style-type: none"> <li>The audio format is not detected or present. Refer to the section below for more information.</li> </ul>
	Green 	<ul style="list-style-type: none"> <li>The AT-HDR-M2C has detected the audio format. Refer to the section below for more information.</li> </ul>

### Audio Input Indicators

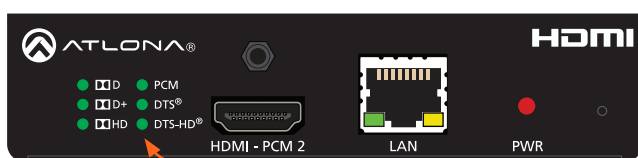
The front panel of the AT-HDR-M2C provides six LED indicators which will display the audio format detected on the HDMI IN port. When a recognizable audio format is detected, the associated indicator will glow solid green.



Audio indicators

LED	Description
	Dolby Digital; lossy audio format supporting up to 5.1 channels
	Dolby Digital Plus; lossy audio format supporting up to 5.1 channels plus support for higher bitrates.
	Dolby TrueHD; lossless audio format supporting up to 7.1 channels
PCM	Indicates the presence of two-channel, 5.1, or 7.1 LPCM audio formats
DTS®	Indicates DTS 5.1
DTS-HD	Indicates DTS-HD Master Audio™ or DTS:X; combined lossy/lossless audio format supporting up to 7.1 channels

## Front-Panel Button

The recessed button on the front panel of the AT-HDR-M2C serves two purposes: 1) to toggle between DHCP and static IP mode and 2) to reset the AT-HDR-M2C to factory-default settings.

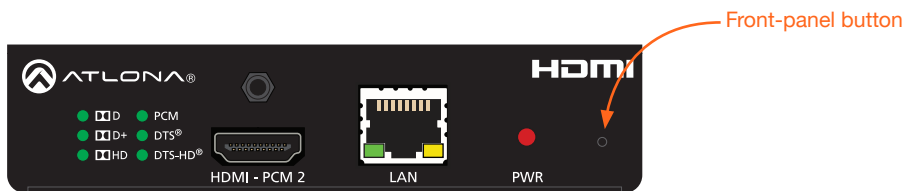

## toggling the IP Mode

The default IP setting for the AT-HDR-M2C is DHCP mode, which allows the device to be automatically assigned an IP address by the DHCP server (if present), after it is connected to a Local Area Network (LAN). The default static IP address is 192.168.1.254. The default subnet mask is 255.255.0.0.

1. Press and hold the IP toggle button for approximately 10 seconds, using the end of a paper clip or other pointed object.
2. Release the button when the **PWR** indicator starts to flash. The number of flashes will indicate the IP mode setting.

PWR LED	Description
2 blinks	Device is in static IP mode.
4 blinks	Device is in DHCP mode.

3. IP configuration is complete. The IP mode can also be set through the [System page \(page 24\)](#) in the built-in web interface.

## Resetting to Factory-Defaults

The same button on the front panel, which allows toggling between IP modes, also allows the AT-HDR-M2C to be reset to factory-default settings.

1. Press and hold the button for more than 20 seconds, using the end of a paper clip or other pointed object.
2. Release the button when the **PWR** indicator starts to flash.
3. The AT-HDR-M2C is now set to factory-default settings. The AT-HDR-M2C can also be set to factory-defaults through the [System page \(page 24\)](#) in the built-in web interface.

## EDID Management

EDID is an acronym for Extended Display Identification Data. Before a source can send a picture and/or audio to a display (or other sink device), the source requests information from the display on what video and audio formats it can support. Once the source has this information, it will send the supported picture and audio resolution that is supported by the display. By default, the AT-HDR-M2C uses a “default” EDID of 1920 x 1080p. The EDID can be changed through the built-in web interface or by executing the PrefTimg API command.

### Loading EDID Presets

The AT-HDR-M2C provides 11 EDID presets. The following table lists available EDID data.

Available Resolutions		
800x600	1366x768	2560x1440
1024x768	1600x900	3840x2160@30Hz
1280x720	1920x1080	3840x2160@60Hz
1280x800	1920x1200	

1. Access the built-in web interface. Refer to [Introduction to the webGUI \(page 17\)](#) for more information.
2. Click **AV Settings** in the menu bar.

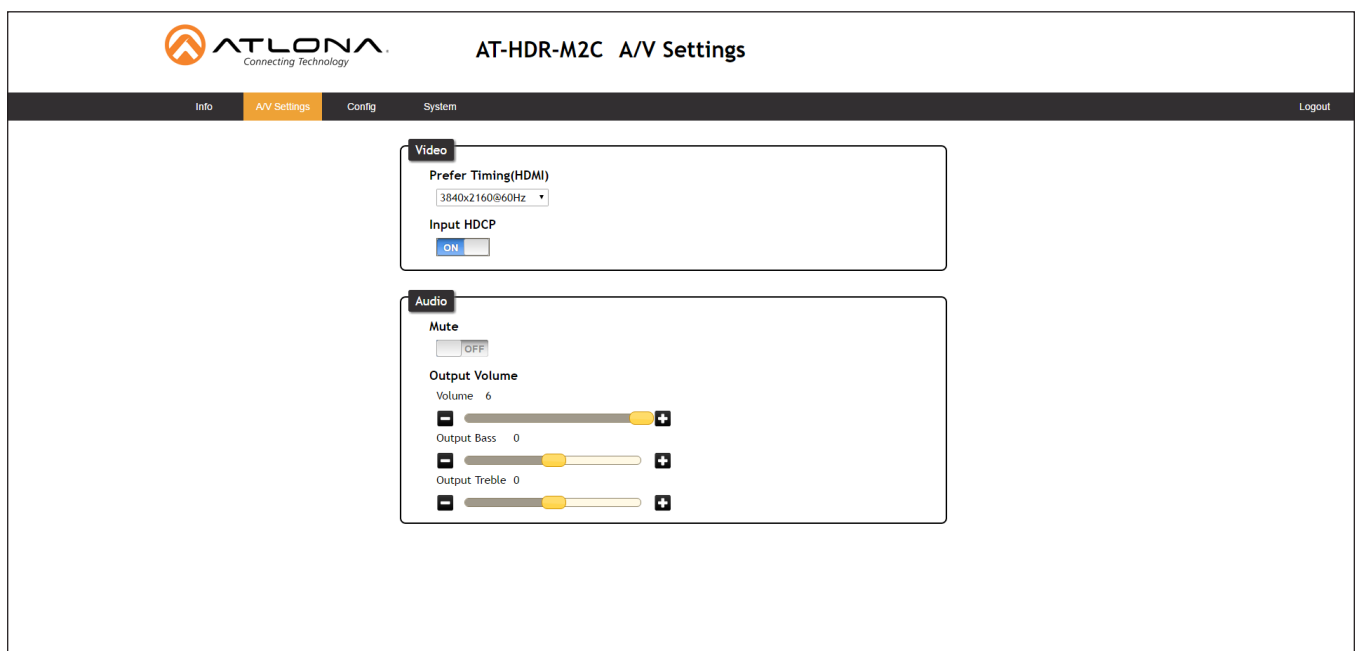

3. Click the **Prefer Timing (HDMI)** drop-down list to select the desired EDID. Once selected, the EDID will be used by the HDMI input on the AT-HDR-M2C.

### Copying a Downstream EDID

In some instances, it may be desirable to use the EDID of a connected display or other sink device. In addition to the 11 EDID presets, the AT-HDR-M2C provides the option to use the EDID from a sink device that is connected to either the **HDMI OUT** or **HDMI PCM** port.

1. Access the built-in web interface. Refer to [Introduction to the webGUI \(page 17\)](#) for more information.
2. Click **AV Settings** in the menu bar.

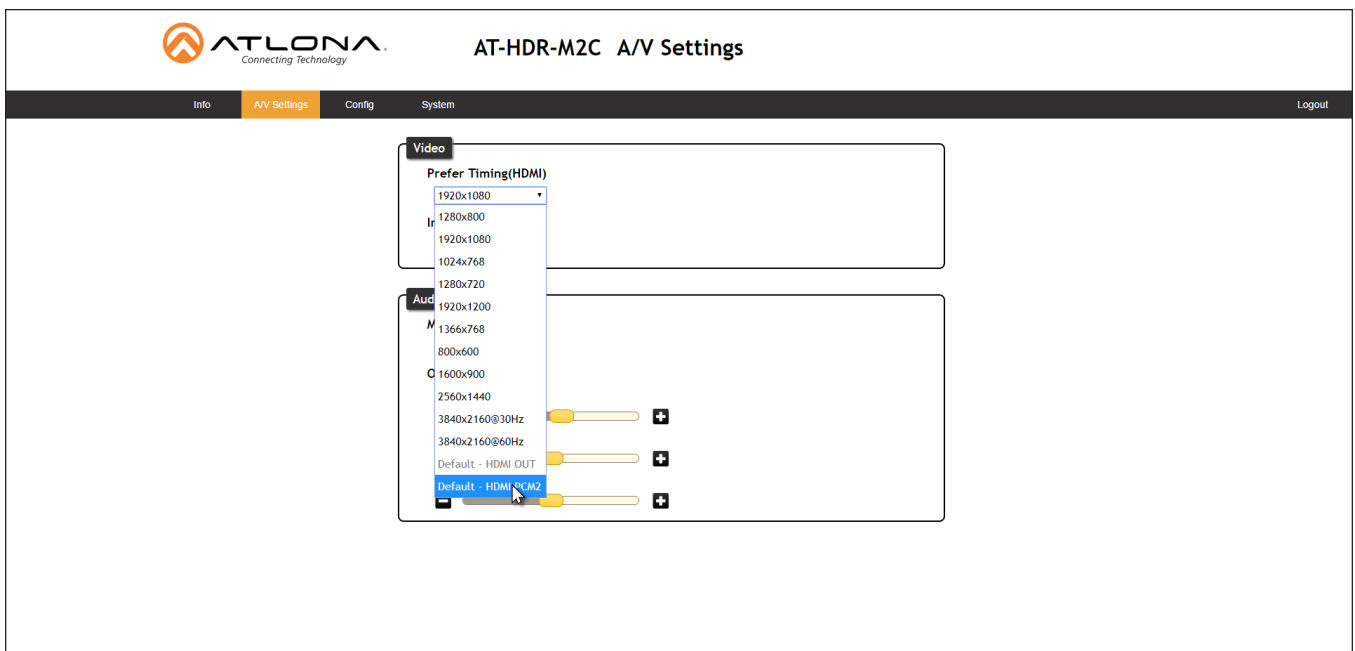

3. Make sure a display (sink) device is connected to either the **HDMI** or **HDMI PCM** port.
4. Click the **Prefer Timing (HDMI)** drop-down list and select either **Default - HDMI OUT** or **Default - HDMI PCM**. Once selected, the AT-HDR-M2C will read the EDID from the downstream sink and be copied to the HDMI input on the AT-HDR-M2C.

Note that these options will only be available if a display (sink) device is detected on one of these ports. For example, if a device is not connected to the **HDMI OUT** port, then the **Default - HDMI OUT** option will be grayed-out.

**NOTE:** If either one of these EDID options is selected, and the sink device is disconnected, then the AT-HDR-M2C will continue to use the EDID from the last connected device. To use a different EDID, a new display device will need to be connected to the port.



# The WebGUI

## Introduction to the webGUI

The AT-HDR-M2C includes a built-in webGUI. Atlona recommends that the web GUI be used to set up the AT-HDR-M2C, as it provides intuitive management of all features.

The AT-HDR-M2C is shipped with DHCP enabled. Once connected to a network, the DHCP server will automatically assign an IP address to the unit. Use an IP scanner to determine the IP address of the AT-HDR-M2C. If a DHCP server is not available or if a static IP address is desired, it can be assigned using the IPStatic command or through the [System page \(page 24\)](#). The default static IP address of the AT-HDR-M2C is 192.168.1.254.

1. Launch a web browser.
2. In the address bar, type the IP address of the AT-HDR-M2C.
3. The **Login** page will be displayed.

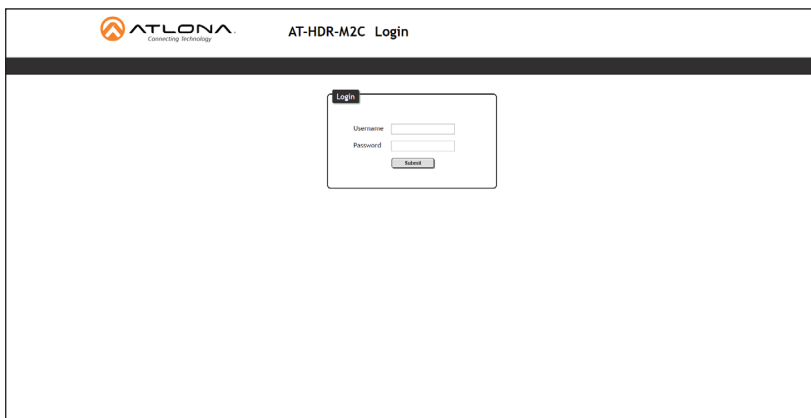

4. Type `root`, using lower-case characters, in the **Username** field.
5. Type `Atlona` in the **Password** field. The password field is case-sensitive. When the password is entered, it will be masked. The password can be changed, if desired. Refer to the [Config page \(page 23\)](#) for more information.
6. Click the **Submit** button or press the ENTER key on the keyboard.

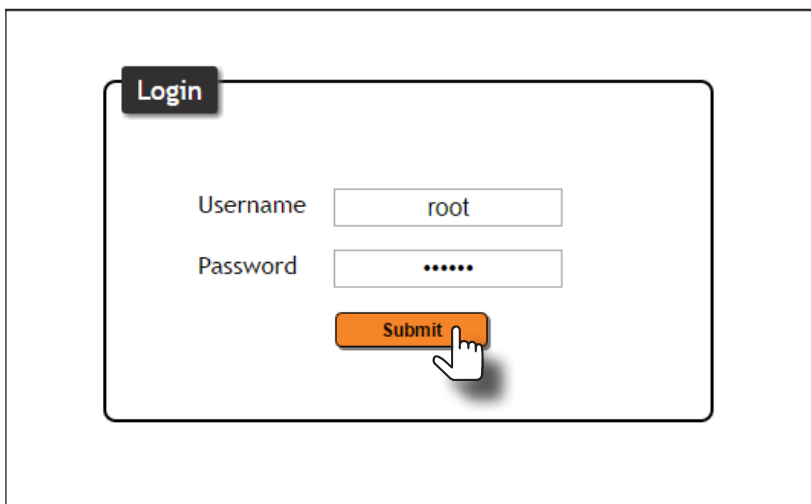

7. The **Info** page will be displayed.

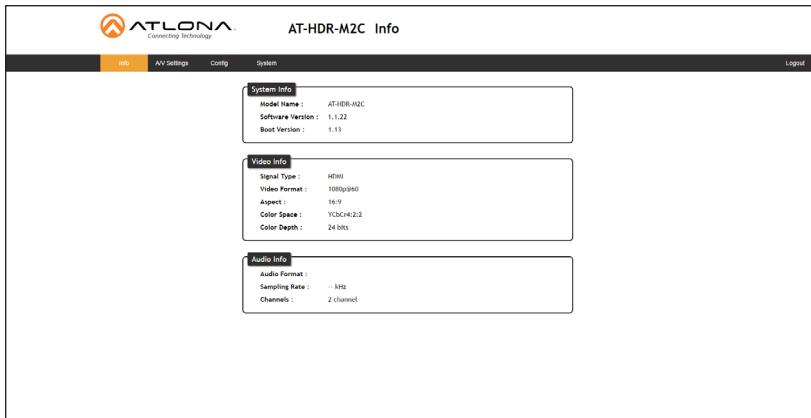

### Menu Bar

The dark-colored bar, near the top of the screen, is the menu bar. When the mouse is moved over each menu element, it will be highlighted in light orange. Once the desired menu element is highlighted, click the left mouse button to access the settings within the menu.

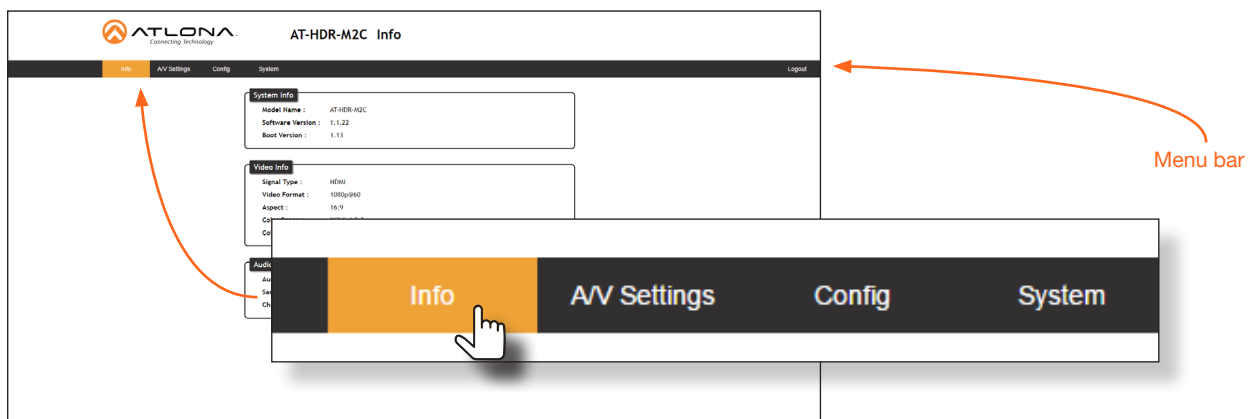

In this example, clicking **A/V Settings**, in the menu bar, will display the **A/V Settings** page.

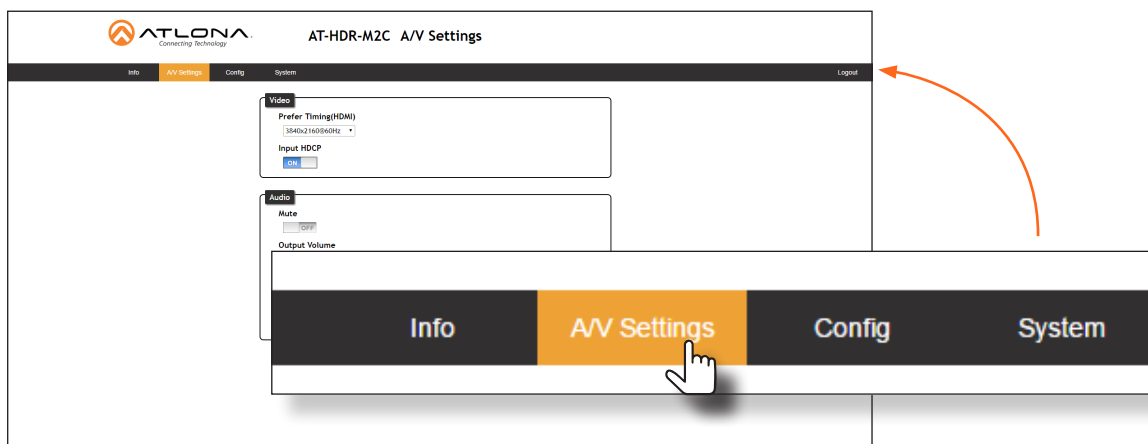

### Toggles

Several settings within the Web GUI use *toggles*, which enable, disable, or assign one of two settings. Generally, when the *toggle* is blue, it means that the feature is *enabled* or ON. If a feature is *disabled*, then the *toggle* will appear gray and be labeled as OFF. Toggle buttons may also indicate its current setting and, when enabled or set to a particular state, may also provide access to another set of controls or text fields within the Web GUI, as shown with the **IP Mode** toggle.

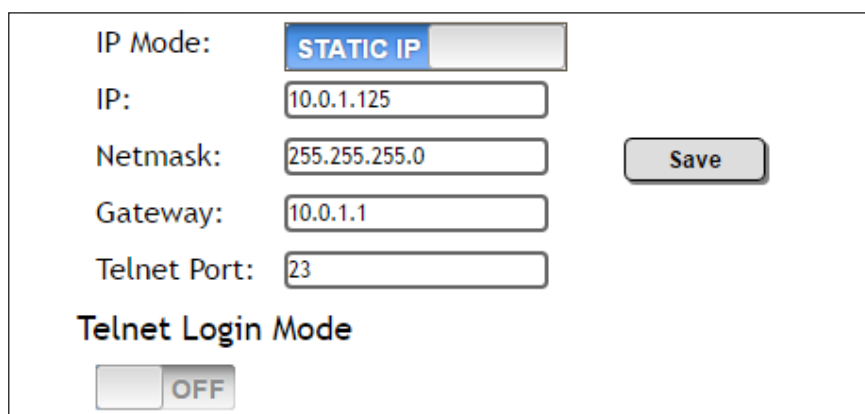

IP Mode: **STATIC IP**

IP: 10.0.1.125

Netmask: 255.255.255.0

Gateway: 10.0.1.1

Telnet Port: 23

Save

Telnet Login Mode

OFF

### Sliders

Click and drag slider controls to change their value.

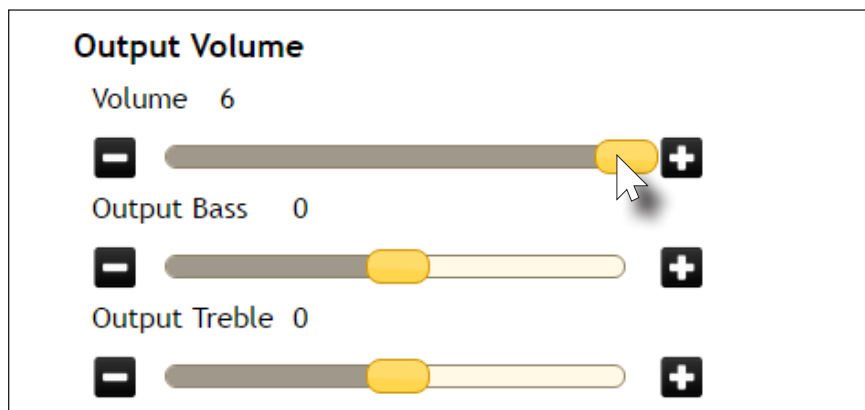

**Output Volume**

Volume 6

Output Bass 0

Output Treble 0

### Buttons

Buttons are used to execute an action or setting. Several pages within the Web GUI include a **Save** button. Clicking the **Save** button will apply and save all settings in the current page. Other buttons, such as the **Factory Defaults** button, under the System page, will reset the AT-HDR-M2C to factory-default settings.

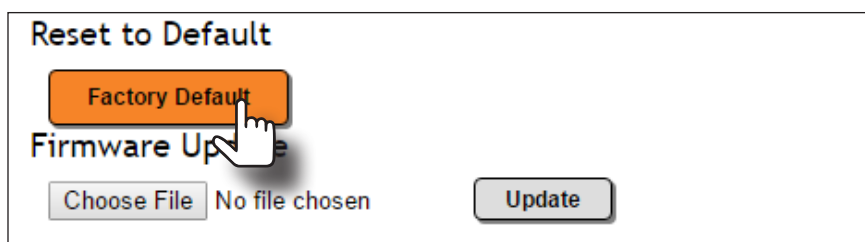

**Reset to Default**

Factory Default

Firmware Update

Choose File No file chosen

Update

## Info page

After logging in, the Info page will be displayed. The **Info** page is divided into three sections: **System Info**, **Video Info**, and **Audio Info**. The **System Info** section displays general information about the AT-HDR-M2C, such as the model name, software, and boot loader version. The **Video Info** section displays information about the input video signal. The **Audio Info** section displays information about the audio format, sampling rate, and the number of audio channels.



ATLONA Connecting Technology		AT-HDR-M2C Info	
Info	AV Settings	Config	System
Logout			
<b>System Info</b>			
Model Name :	AT-HDR-M2C		
Software Version :	1.1.22		
Boot Version :	1.13		
<b>Video Info</b>			
Signal Type :	HDMI		
Video Format :	1080p@60		
Aspect :	16:9		
Color Space :	YCbCr4:2:2		
Color Depth :	24 bits		
<b>Audio Info</b>			
Audio Format :			
Sampling Rate :	-- kHz		
Channels :	2 channel		

### System Info

#### Model Name

The model SKU of this product.

#### Software Version

The version of firmware that the AT-HDR-M2C is running. Always make sure to check the AT-HDR-M2C product page, on the Atlona web site, for the latest version of firmware.

#### Boot Version

The version of the boot loader.

### Video Info

#### Signal Type

The type of input signal.

#### Video Format

The input resolution of the source device.

#### Aspect

Aspect ratio of the input signal.

#### Color Space

Displays the color space and chroma sub-sampling of the input signal.

#### Color Depth

The color depth of the input signal.

## Audio Info

### Audio Format

The audio format detected on the input. The AT-HDR-M2C will recognize and display the following audio formats:

Format	Description
Dolby Digital	Lossy audio format supporting up to 5.1 channels
Dolby Digital Plus	Lossy audio format supporting up to 5.1 channels plus support for higher bitrates.
Dolby True HD	Lossless audio format supporting up to 7.1 channels
PCM	Indicates the presence of two-channel, 5.1, or 7.1 LPCM audio formats
DTS	Indicates DTS 5.1
DTS-HD	Indicates DTS-HD Master Audio™ or DTS:X; combined lossy/lossless audio format supporting up to 7.1 channels

### Sampling Rate

The sampling rate of the input audio signal, expressed in kilohertz (kHz).

### Channels

The number of audio channels detected on the input signal.

## A/V Settings page

The **A/V Settings** page is divided into two sections: **Video** and **Audio**. The **Video** section allows the preferred input timing to be selected as well as whether or not HDCP content is allowed to pass. The **Audio** section provides options to control the output audio volume, muting, treble, and bass.

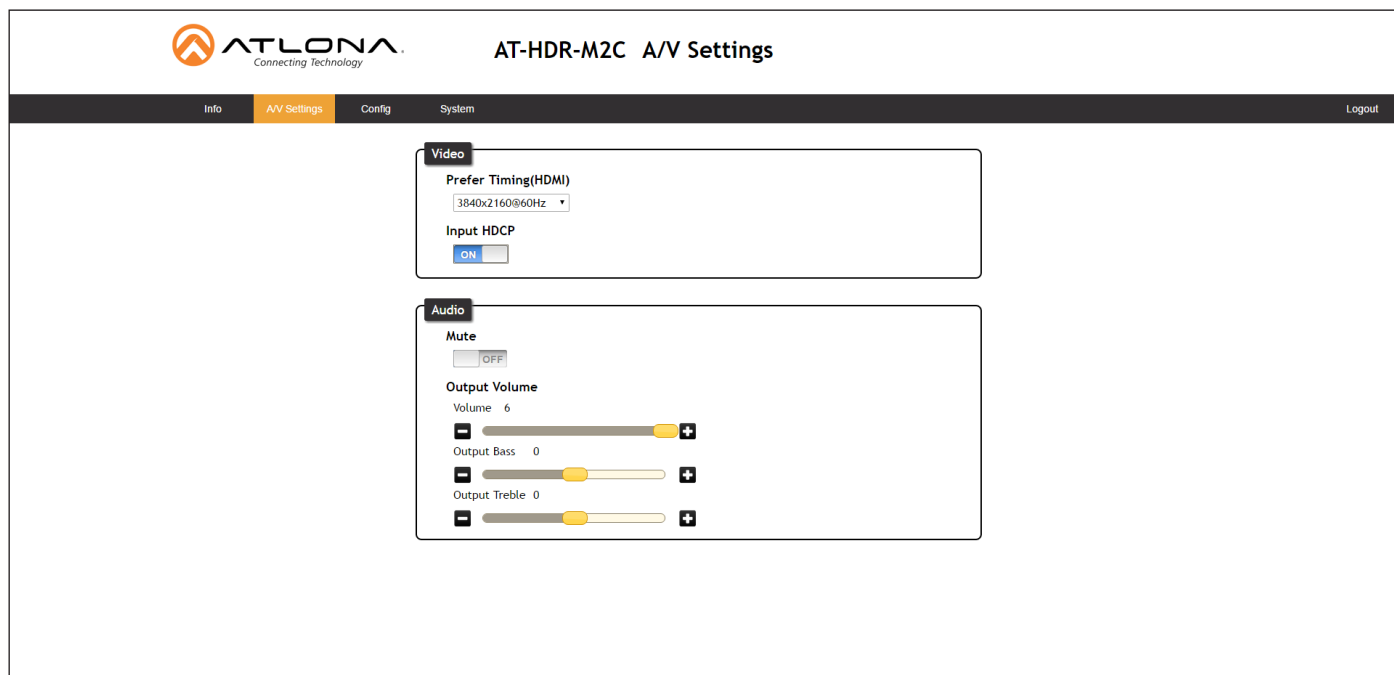

### Video

#### Prefer Timing (HDMI)

Click this drop-down list to select the desired input.

Available Resolutions			
800x600	1366x768	2560x1440	Default - HDMI PCM2
1024x768	1600x900	3840x2160@30Hz	
1280x720	1920x1080	3840x2160@60Hz	
1280x800	1920x1200	Default - HDMI OUT	

#### Input HDCP

Click this toggle to report HDCP compliance or non-compliance to the source device.

- **ON** - Reports to the source device that the AT-HDR-M2C is an HDCP-compliant sink.
- **OFF** - Reports to the source device that the AT-HDR-M2C is a non-HDCP-compliant sink.

### Audio

#### Mute

Click this toggle to the **OFF** position to mute all audio on the output.

#### Volume

Click and drag this slider bar to adjust the audio volume. Range: -80 to 6.

#### Output Bass

Click and drag this slider bar to adjust the bass of the audio output. Range: -15 to 15.

#### Output Treble

Click and drag this slider bar to adjust the treble of the audio output. Range: -15 to 15.

## Config page

The **Config** page provides management of usernames and passwords. The administrator username (“root”) cannot be changed.

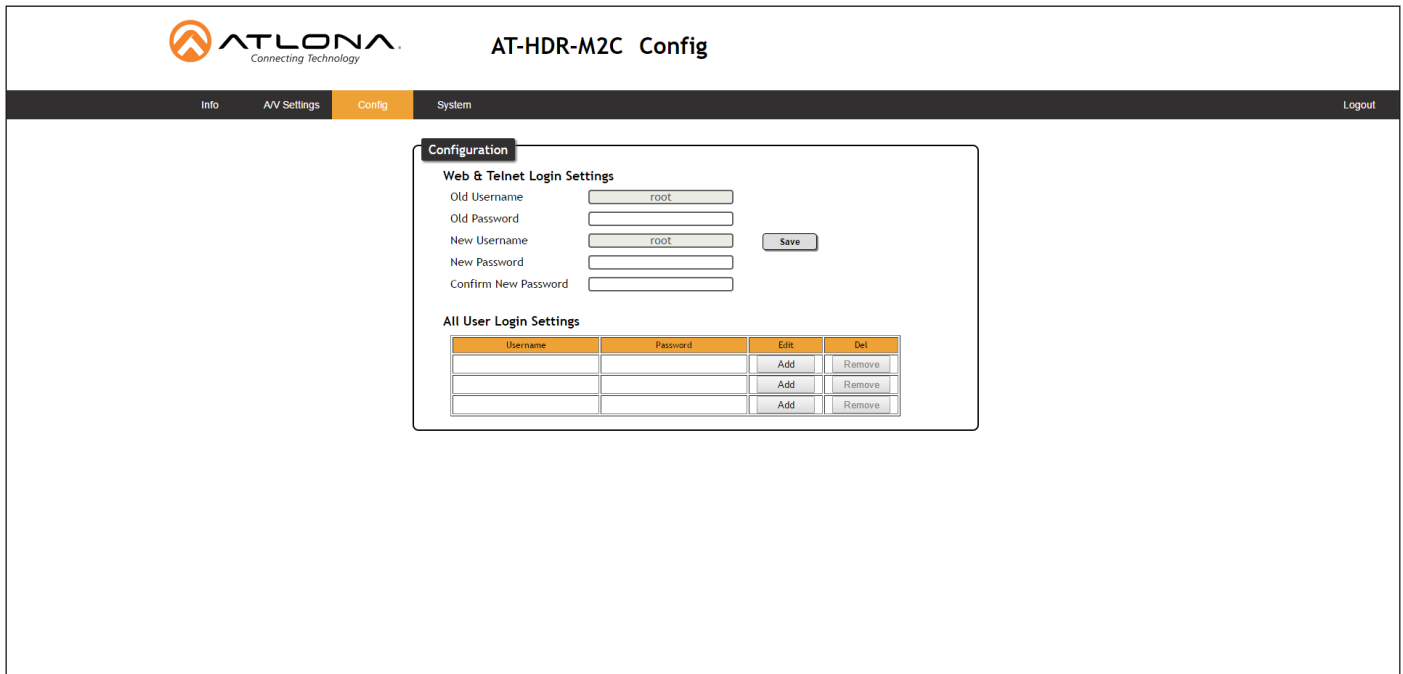

The screenshot shows the AT-HDR-M2C Config page. At the top, there is a navigation bar with tabs for Info, AV Settings, Config (selected), and System. A Logout link is visible in the top right corner. The main content area is titled 'Configuration' and contains two sections:

**Web & Telnet Login Settings**

Old Username:

Old Password:

New Username:

New Password:

Confirm New Password:

**All User Login Settings**

Username	Password	Edit	Del
		<input type="button" value="Add"/>	<input type="button" value="Remove"/>
		<input type="button" value="Add"/>	<input type="button" value="Remove"/>
		<input type="button" value="Add"/>	<input type="button" value="Remove"/>

### Configuration

#### Old Username

This field cannot be changed. “root” is the administrator user.

#### Old Password

Enter the current password for the “root” username in this field. The default password is “Atlona”.

#### New Username

This field cannot be changed.

#### Save

Click this button to save all changes.

### All User Login Settings

- **Username**  
Displays the username.
- **Password**  
Displays the password for the associated username.
- **Edit**  
Click the **Add** button, in this column, to edit the username and password in the row.
- **Del**  
Click the **Remove** button to delete the user in the row. This button will only be available if a username and password have been created.

## System page

The **System** page is divided into two sections: **Network** and **System**. The **Network** section allows configuration of the IP settings of the AT-HDR-M2C. The **System** provides controls for resetting the AT-HDR-M2C to factory-default settings and updating the firmware.

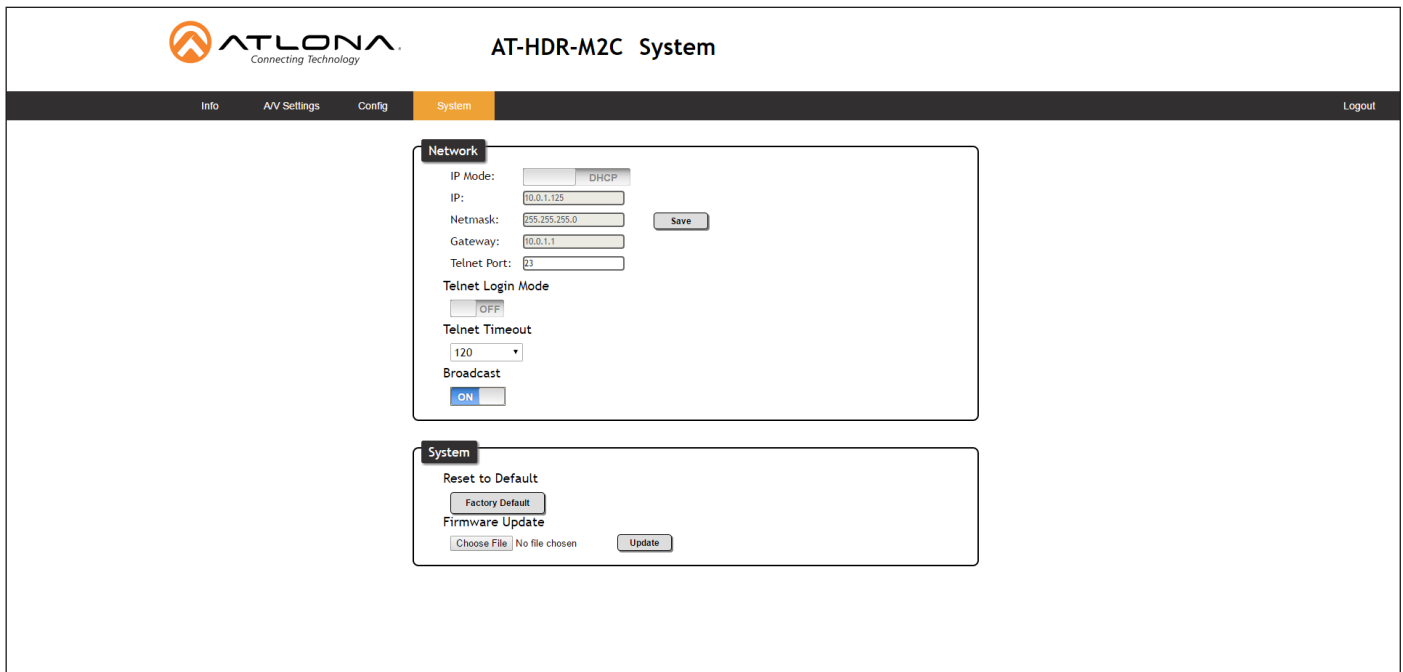

### Network

#### IP Mode

Click this toggle to set the AT-HDR-M2C to DHCP or static mode. By default, the AT-HDR-M2C is in DHCP mode.

#### IP

Enter the IP address of the AT-HDR-M2C in this field. This field will only be available when the **IP Mode** is set to **Static**. The default static IP address is 192.168.1.254.

#### Netmask

Enter the subnet mask of the AT-HDR-M2C in this field. This field will only be available when the **IP Mode** is set to **Static**.

#### Save

Click this button to save all changes in the **Network** group.

#### Gateway

Enter the gateway (router) address in this field. This field will only be available when the **IP Mode** is set to **Static**.

#### Telnet Port

Enter the Telnet port in this field. Telnet uses a default port number of 23.

#### Telnet Login Mode

Click this toggle to set the Telnet Login Mode to ON or OFF.

#### Telnet Timeout

Click this drop-down list to select the timeout interval, in seconds.

#### Broadcast

Click this toggle to set the Broadcast mode ON or OFF.



## System

### Factory Default

Click this button to reset the AT-HDR-M2C to factory-default settings.

### Choose File

Click this button to select the firmware file.

### Update

Click this button to begin the firmware update procedure.

Refer to [Updating the Firmware \(page 26\)](#) for more information on firmware updates.

# Appendix

## Updating the Firmware

Updating the firmware can be completed using either the USB interface or the web GUI. Atlona recommends using the web GUI for updating the firmware. However, if a network connection is not available, the AT-HDR-M2C firmware can be updated using a USB-A to USB mini-B cable.

### Using the Web GUI

#### Requirements

- AT-HDR-M2C
  - Firmware file (.bin file)
  - Computer
1. Connect an Ethernet cable from the computer, containing the firmware, to the same network where the AT-HDR-M2C is connected.
  2. Go to the **System** page (page 24) in the web GUI.

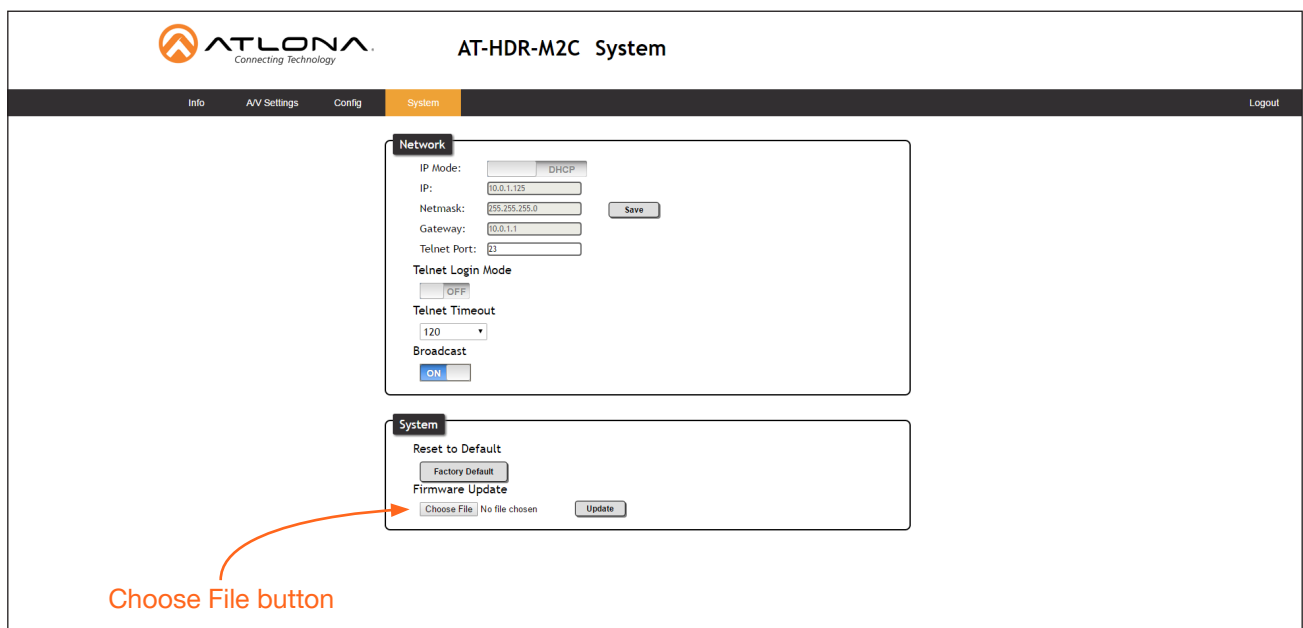

3. Click the **Choose File** button, under the **Firmware Update** section.
4. Browse to the location of the firmware file, select it, and click the **Open** button.
5. Click the **Update** button.
6. The following dialog will be displayed.

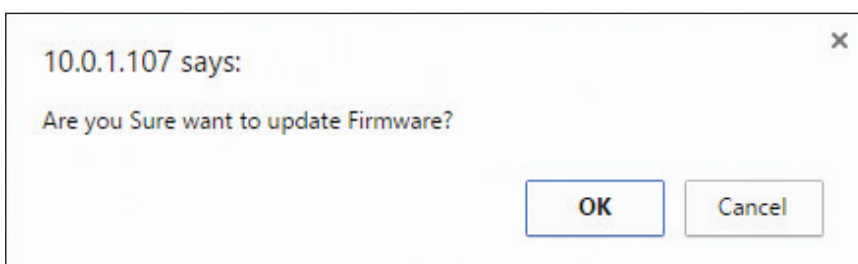

7. Click the **OK** button to begin the firmware update process. Click the **Cancel** button to abort the process.
8. The update process will take approximately 60 seconds and will automatically reboot the AT-HDR-M2C. During the update process, the **PWR** LED indicator will flash.
9. After the firmware update process is complete, the **Login** screen will be displayed.

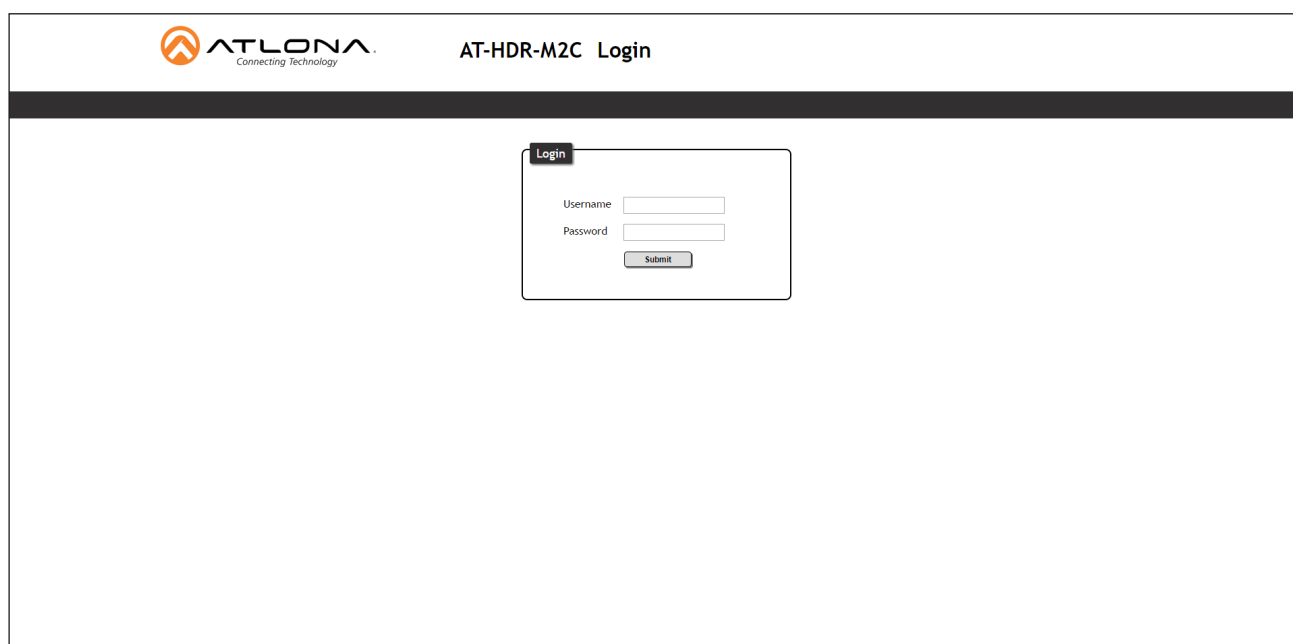

## Using USB

### Requirements

- AT-HDR-M2C
- Firmware file (.bin file)
- Computer
- USB-A to USB mini-B cable

1. Disconnect the power from the AT-HDR-M2C.
2. Connect the USB-A to USB mini-B cable from the computer to the **FW** port on the AT-HDR-M2C.

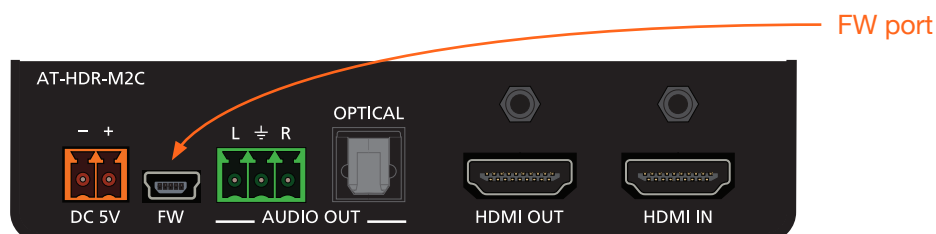

3. Reconnect the power to the AT-HDR-M2C.
4. The USB UPDATE folder will be displayed.

If this folder is not displayed, automatically, select the USB UPDATE drive from Windows Explorer, as shown on the next page.

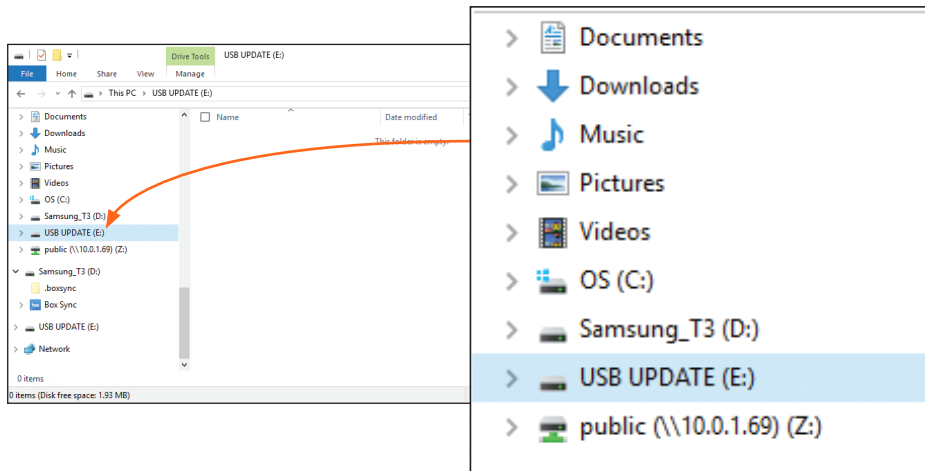

4. Delete all files from the USB UPDATE drive, if any are present.
5. Drag-and-drop the firmware file to the drive.
6. After the file has been copied, disconnect the USB cable from both the computer and the AT-HDR-M2C.
7. The AT-HDR-M2C will automatically reboot, completing the firmware update process.

## Mounting Instructions

The AT-HDR-M2C includes two mounting brackets, which can be used to attach the unit to any flat surface. Use the two enclosure screws, on the sides of the unit to attach the mounting brackets.

1. Using a small Phillips screwdriver, remove the two screws from the left side of the enclosure.

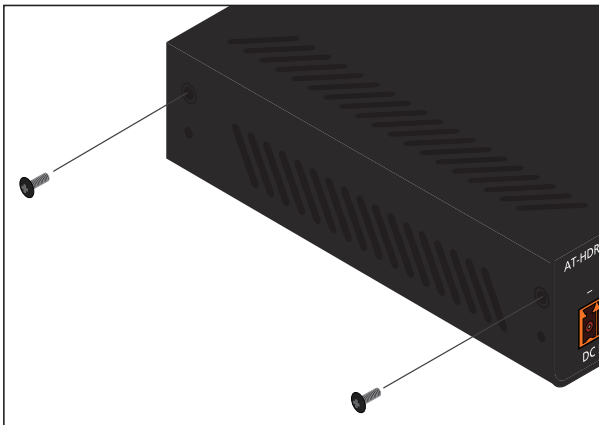

2. Position one of the mounting brackets, as shown below, aligning the holes on the side of the enclosure with one set of holes on the mounting bracket.
3. Repeat steps 1 and 2 to attach the second mounting bracket to the opposite side of the unit.
4. Mount the unit to a flat surface using the oval-shaped holes, on each mounting bracket. If using a drywall surface, a #6 drywall screw is recommended.

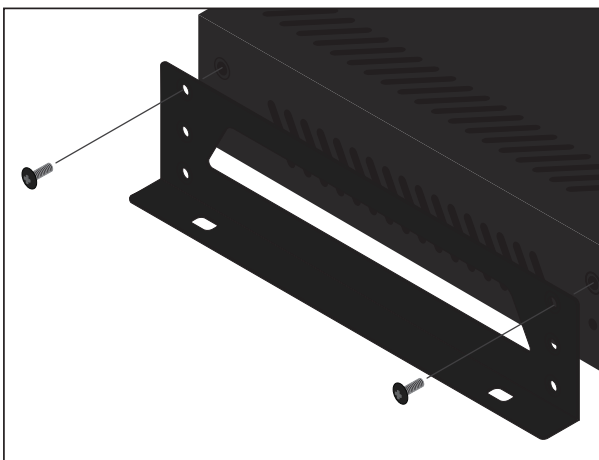

**NOTE:** Mounting brackets can also be inverted to mount the unit under a table or other flat surface.

## Default Settings

The following tables list the factory-default settings for the AT-HDR-M2C.

A/V Settings		
Video	Preferred Timing (HDMI) Input HDCP	1920 x 1080 ON
Audio	Mute Output Volume Output Bass Output Treble	OFF 0 0 0

Config		
Configuration	Username (cannot be changed) Password	root Atlona

System		
Network	IP Mode IP (static default) Netmask (static default) Gateway (static default) Telnet Port Telnet Login Mode Telnet Timeout (seconds) Broadcast	DHCP 192.168.1.254 255.255.0.0 192.168.1.1 23 OFF 120 ON

 **NOTE:** When the AT-HDR-M2C is set to static IP mode, then the IP, Netmask, and Gateway settings will be used by default.

## Specifications

Video	
HD/SD	4096x2160@24/25/30/50/60Hz, 3840x2160@24/25/30/50/60Hz, 2048x1080p, 1080p@23.98/24/25/29.97/30/50/59.94/60Hz, 1080i@50/59.94/60Hz, 720p@50/59.94/60Hz, 576p, 576i, 480p, 480i
VESA	1920x1200, 1680x1050, 1600x1200, 1440x900, 1400x1050, 1366x768, 1360x768, 1280x1024, 1280x800, 1152x768, 1024x768, 800x600, 640x480
Color Space	YUV, RGB
Chroma Subsampling	4:4:4, 4:2:2, 4:2:0
Color Depth	8-bit, 10-bit, 12-bit

Audio	
Analog Output	PCM 2Ch (de-embedded)
Optical Output	PCM 2Ch (de-embedded)
HDMI Output	PCM 2Ch, Dolby Digital, Dolby Digital Plus, Dolby TrueHD, DTS 5.1
Sample Rate	32kHz, 44.1 kHz, 48 kHz, 88.2 kHz, 96 kHz, 176.4 kHz, 192 kHz
Bit Rate	up to 24-bit
THD	0.003593%, 20 Hz, 1 kHz - 20 kHz
SNR	110.009 dB
Frequency Range	20 Hz to 20 kHz
Bass	+12 dB to -15 dB @ 20 Hz - 20 kHz
Treble	+15 dB to -15 dB @ 20 Hz - 20 kHz

Resolution / HDMI cable length	4K / UHD - Feet / Meters		1080p - Feet / Meters	
HDMI @ 60 Hz	6	2	30	10
HDMI UHD @ 24 Hz	16	5	50	15

Signal	
Bandwidth	18 Gbps
CEC	Compliant
HDCP	2.2-compliant

Temperature	Fahrenheit	Celsius
Operating	32 to 122	0 to 50
Storage	-20 to 60	-4 to 140
Humidity (RH)	20% to 90%, non-condensing	

Power	
Consumption	6.6 W
Supply	Input: 110 - 220 V AC, 50/60 Hz; Output: 5 V DC, 4 A

Dimensions	Inches	Millimeters
H x W x D	1.02 x 4.29 x 5.00	26 x 109 x 127
H x W x D (w / ears)	1.02 x 4.29 x 5.39	26 x 109 x 137

Weight	Pounds	Kilograms
Device	0.8	0.36

Certification	Product	Power Supply
Device	CE, FCC	CE, FCC, cULus, RoHS, CCC, RCM

# Index

---

- A**
- Audio**
  - connector 10
  - indicators 9, 13
  - muting 22
- B**
- Bass**
  - adjusting 22
- C**
- Connection**
  - diagram 10
  - instructions 10
- Contents**
  - package 8
- Customer support** 3
- D**
- Default settings** 30
- E**
- EDID**
  - copying downstream data 16
  - loading preset 15
- F**
- FCC statement** 6
- Features** 8
- Firmware**
  - displaying 20
  - updating 26
- G**
- Gateway**
  - setting 24
- H**
- HDMI OUT** 9
- I**
- Installation** 10
- IP address**
  - default 24
  - setting 24
- IP mode**
  - tooggling 14
- IP settings**
  - default 30
- L**
- LED**
  - 5V 9
  - SOURCE 9
- M**
- Mounting instructions** 29
- Muting**
  - audio 22
- O**
- Operating notes** 3
- P**
- Panel descriptions** 9
- Password**
  - setting 23
- Power**
  - connector 10
- R**
- Reset**
  - factory-default 14, 25
- Resolution**
  - setting 22
- S**
- Safety information** 6
- Specifications** 31
- Subnet mask**
  - setting 24
- T**
- Telnet port**
  - default 24
  - setting 24
- Treble**
  - adjusting 22
- U**
- Users**
  - adding 23
  - editing 23
  - removing 23
- V**
- Volume**
  - output, adjusting 22
- W**
- Warranty** 4
- Web GUI** 17



