

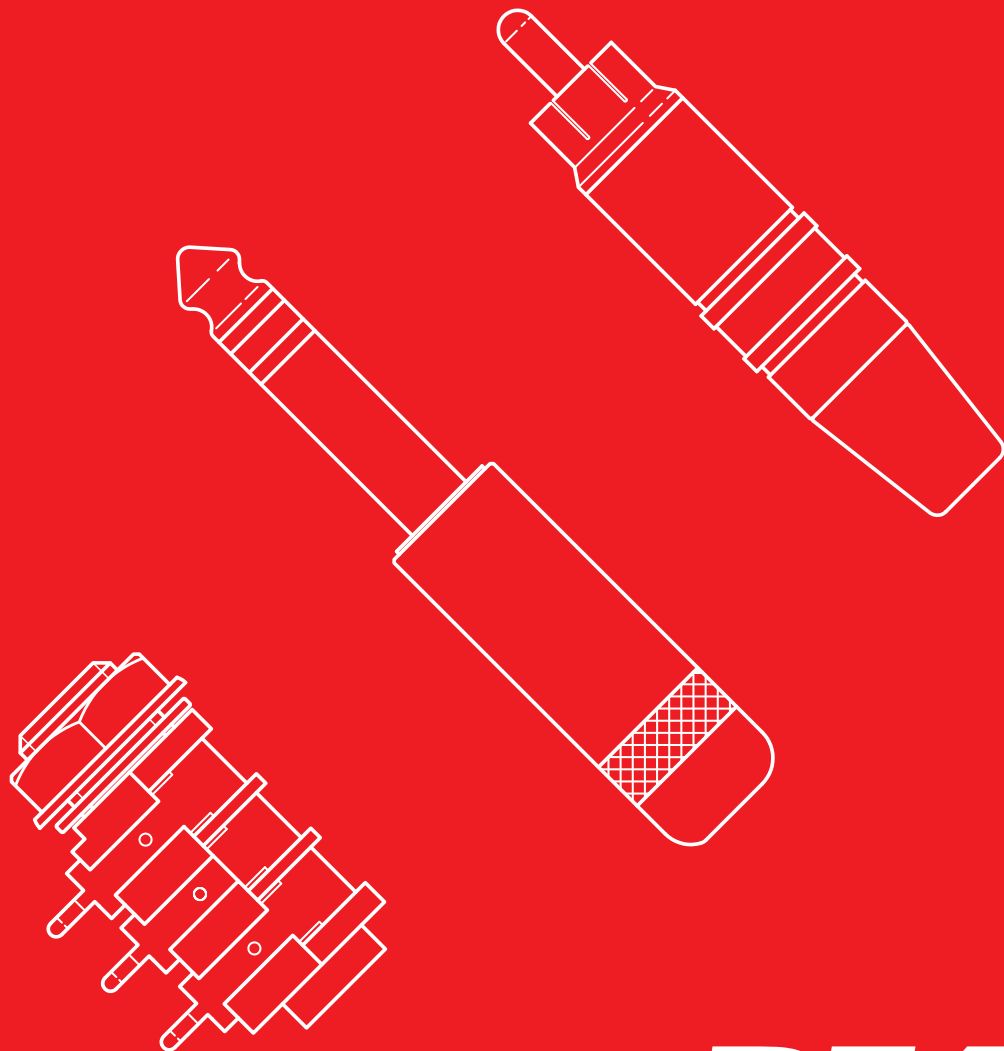

Product Guide | 2015/16





Content	Page
TINY xlr Cable Connectors	4
TINY xlr Chassis Connectors and Adapters	6
1/4" Vertical Jacks	8
1/4" Phone Jacks	10
1/4" Phone Plugs	12
3.5 mm Phone Plugs, Cable Jacks and Adapter ...	14
Phono "RCA"	16
DIN Connectors	18
Patch Box & Stage Boxes	20
Dual Banana Plugs	22

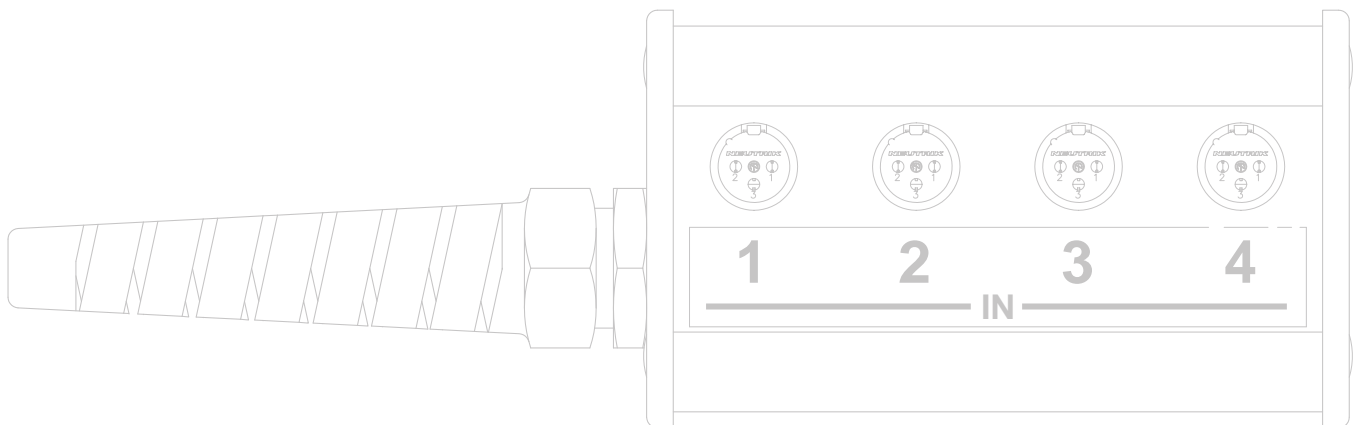

REAN®

With the brand REAN, the world's leading supplier of professional audio and video connectors – Neutrik AG – offers another interesting product range.

Excellent cost-performance ratio, attractive design and reliable functionality are the strengths of REAN.

Based on long-time know-how audio and video connectors for professional applications are developed and produced on up to date production facilities. An efficient logistics system and a global sales network make a high availability and short delivery times possible. The REAN product range is an alternative solution for cost sensitive applications.

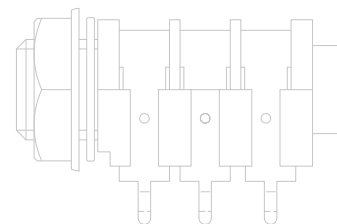
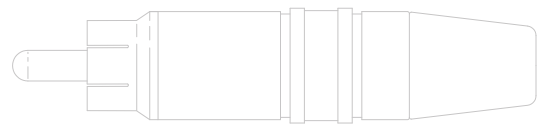

REAN a brand of Neutrik AG

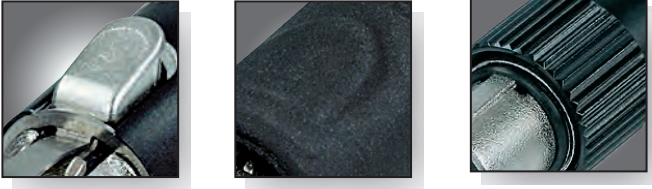

TINY xlr Cable Connectors



RT3FC-B



RT4FC-B-W



RT4FCT-B



RT3MC-B

- 3, 4 and 5 pole versions available
- Easy to assemble
- Robust metal housing with best flex relief
- Shielded system – high noise immunity and EMI protection
- Intuitive and rugged locking mechanism provides secure locking system
- Millionfold proven chuck type strain relief – up to 4.0 mm cable diameter

- Keyed insert and strain relief to avoid mispositioning/ rotation of insert respectively cable
- RT*FC-B-W: optional sealing boot (patent pending) for water/sweat protection if mated with RT*MP
- RT*FCT-B: screw locking design for outstanding ruggedness – fits with common rear mountable connectors
- BRT-L: Accessory kit for cables from 4.0 – 5.0 mm

RT3FC-B

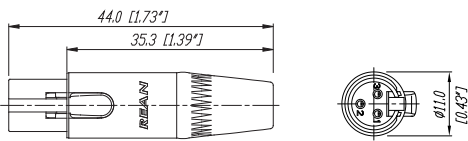

RT3FCT-B

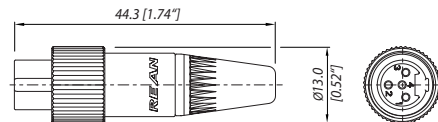

RT3FC-B-W

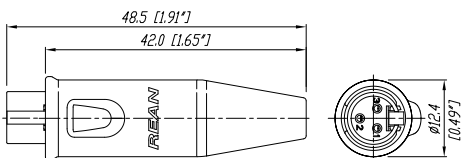

RT3MC-B

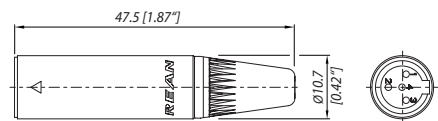

Female Pin-Layouts (front view)

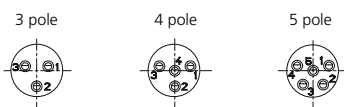

Male Pin-Layouts (front view)

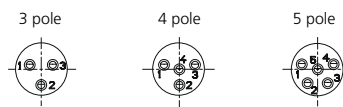

Ordering Information

Type No.		Description
Cable connectors		
Female	Male	
RT3FC-B	RT3MC-B	3 pole TINY cable connector, black metal shell, gold plated contacts
RT4FC-B	RT4MC-B	4 pole TINY cable connector, black metal shell, gold plated contacts
RT5FC-B	RT5MC-B	5 pole TINY cable connector, black metal shell, gold plated contacts
RT*FC-B-D	RT*MC-B-D	TINY cable connector, black metal shell, gold plated contacts; bulk packed, to be ordered in multiples of 100 pcs.
Cable connectors female water resistant		
RT3FC-B-W		3 pole TINY female cable connector, black metal shell, water resistant boot, gold plated contacts
RT4FC-B-W		4 pole TINY female cable connector, black metal shell, water resistant boot, gold plated contacts
RT5FC-B-W		5 pole TINY female cable connector, black metal shell, water resistant boot, gold plated contacts
RT*FC-B-W-D		TINY female cable connector, black metal shell, water resistant boot, gold plated contacts; bulk packed, to be ordered in multiples of 100 pcs.
Cable connectors female screw locking		
RT3FCT-B		3 pole TINY female cable connector with screw locking, black metal shell & nut, gold plated contacts
RT4FCT-B		4 pole TINY female cable connector with screw locking, black metal shell & nut, gold plated contacts
RT5FCT-B		5 pole TINY female cable connector with screw locking, black metal shell & nut, gold plated contacts
RT*FCT-B-D		TINY female cable connector with screw locking, black metal shell & nut, gold plated contacts; bulk packed, to be ordered in multiples of 100 pcs.
Accessories		
BRT-L		Bushing and chuck for cable diameters 4.0 – 5.0 mm

Specification

Cable connectors
RT*FC-B*/RT*MC-B*

Screw locking
RT*FCT-B*

Electrical	Cable connectors RT*FC-B*/RT*MC-B*	Screw locking RT*FCT-B*
Rated current per contact	< 5 A	< 5 A
Contact resistance	< 10 mΩ	< 10 mΩ
Insulation resistance	> 1 GΩ	> 1 GΩ
Dielectric strength	> 500 V rms	> 500 V rms
Mechanical		
Lifetime	> 5'000 mating cycles	> 5'000 mating cycles
Cable O.D. range	2.0 – 4.0 mm	2.0 – 4.0 mm
Wiring	solder contacts	solder contacts
Max. wire size	0.22 mm ² / 24 AWG	0.22 mm ² / 24 AWG
Material		
Bushing	ABS	ABS
Contacts	female CuSn6 / male CuZn39Pb3	CuSn6
Contact plating	Au plated	Au plated
Insert	PA 6 30% GR	PA 6 30% GR
Shell (housing)	ZnAl4Cu1	ZnAl4Cu1
Shell plating	black	black
Strain relief	PVC	PVC
Protection boot	EPDM	–
Locking nut	–	Al, black anodized
Environment		
Operating temperature	-30°C to +85°C	-30°C to +85°C
Solderability	complies with IEC68-2-20	complies with IEC68-2-20



TINY xlr Chassis Connectors



RT3MP



RT4MPR

TINY xlr Adapters



RA3FT-B



RA3MT-B

- Front and rear mountable receptacles in 3, 4 and 5 pole design
- Watertight chassis connector, even in unmated condition
- RT*MP provides water resistant connection if mated with RT*FC-B-W

- Easy and fast solution to interconnect mini XLRs
- Rugged metal housing
- Mini XLR 3 pin to XLR-Male or XLR-Female

RT3MP

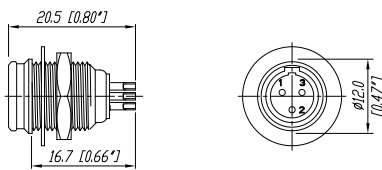

Panel Cutout

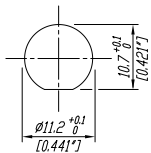

Male Pin-Layouts (front view)

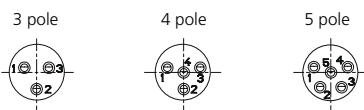

RA3FT-B

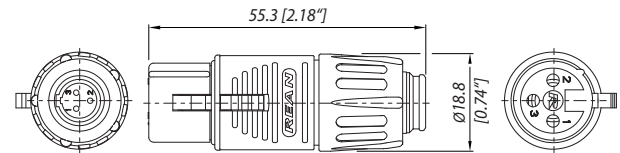

RA3MT-B

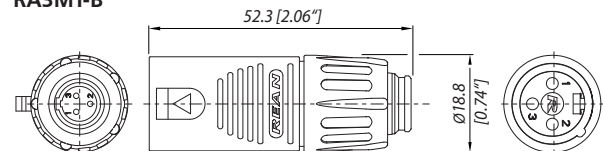

Ordering Information

Type No.	Description
Chassis connectors	
RT3MP	3 pole TINY male chassis connector, nickel metal housing, gold plated contacts, max. panel thickness: 6 mm
RT4MP	4 pole TINY male chassis connector, nickel metal housing, gold plated contacts, max. panel thickness: 6 mm
RT5MP	5 pole TINY male chassis connector, nickel metal housing, gold plated contacts, max. panel thickness: 6 mm
RT*MP-D	TINY male chassis connector, nickel metal housing, gold plated contacts, max. panel thickness: 6 mm; bulk packed, to be ordered in multiples of 100 pcs.
Chassis connectors rearmountable	
RT3MPR	3 pole TINY rearmountable, male chassis connector, nickel metal housing, gold plated contacts, max. panel thickness: 3 mm
RT4MPR	4 pole TINY rearmountable, male chassis connector, nickel metal housing, gold plated contacts, max. panel thickness: 3 mm
RT5MPR	5 pole TINY rearmountable, male chassis connector, nickel metal housing, gold plated contacts, max. panel thickness: 3 mm
RT*MPR-D	TINY rearmountable male chassis connector, nickel metal housing, gold plated contacts, max. panel thickness: 3 mm; bulk packed, to be ordered in multiples of 100 pcs.
Adapters	
RA3FT-B	3 pole adapter TINY male to female XLR, black metall shell, gold plated contacts
RA3MT-B	3 pole adapter TINY male to male XLR, black metall shell, gold plated contacts

Specification

	Chassis connectors RT*MP*	Adapters RA*T-B
Electrical		
Rated current per contact	< 5 A	–
Contact resistance	< 10 mΩ	≤ 5 mΩ
Insulation resistance	> 1 GΩ	> 1 GΩ
Dielectric strength	> 500 V rms	500 V rms
Mechanical		
Lifetime	> 5'000 mating cycles	> 5'000 mating cycles
Wiring	solder contacts	–
Max. wire size	0.22 mm ² / 24 AWG	–
Material		
Contacts	CuZn39Pb3	female CuSn6 / male CuZn39Pb3
Contact plating	Au plated	Au plated
Insert	PA 6.6 30% GR	PA 6 30% GR
Shell (housing)	ZnAl4Cu1	ZnAl4Cu1
Shell plating	nickel	black
Environment		
Operating temperature	-30°C to +85°C	-20°C to +65°C
Solderability	complies with IEC68-2-20	–

1 / 4 " Jacks



1 / 4 " Vertical Jacks



RJ3VM



RJ5VM



RJ3VI-D1



RJ5VI-D1

- Vertical PCB-mount – Fit's widely used PCB layout of existing vertical jacks
- Space saving 1/4" jack – enables highest packing density
- Circumferential contact arrangement – provides reliable switching function
- Integrated body stop for the inserted 1/4" plug – ensures best conductivity independent from mating tip shape
- Spring loaded ground contact – maintains superior contact integrity

RJ3VM

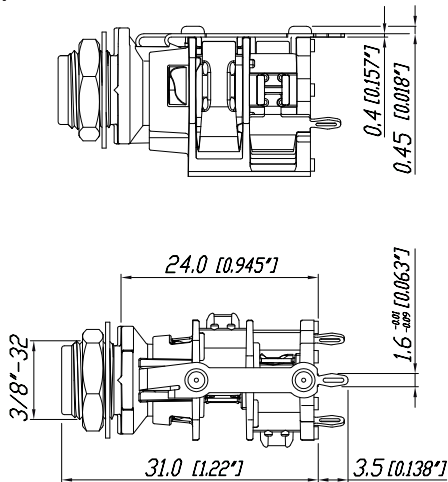

RJ5VM

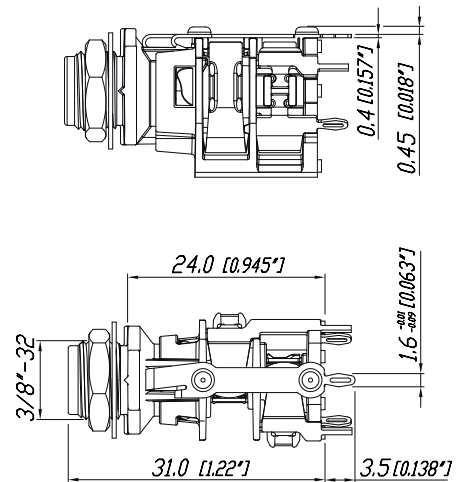

Ordering Information

Type No.	Description
1/4" Vertical Jack (bulk packed, to be ordered in multiples of 100 pcs.)	
RJ3VM	1/4" TRS Jack, vertical PCB, metal nose, with nut and washer, no normalling contacts
RJ5VM	1/4" TRS Jack, vertical PCB, metal nose, with nut and washer, with tip and ring normalling contacts
RJ3VM-D1	1/4" TRS Jack, vertical PCB D1, metal nose, with nut and washer, no normalling contacts
RJ5VM-D1	1/4" TRS Jack, vertical PCB D1, metal nose, with nut and washer, with tip and ring normalling contacts
RJ3VM-S	1/4" TRS Jack, with solder lugs, metal nose, with nut and washer, no normalling contacts
RJ5VM-S	1/4" TRS Jack, with solder lugs, metal nose, with nut and washer, with tip and ring normalling contacts
RJ3VI	1/4" TRS Jack, vertical PCB, plastic nose, with nut and washer, no normalling contacts
RJ5VI	1/4" TRS Jack, vertical PCB, plastic nose, with nut and washer, with tip and ring normalling contacts
RJ3VI-D1	1/4" TRS Jack, vertical PCB D1, plastic nose, with nut and washer, no normalling contacts
RJ5VI-D1	1/4" TRS Jack, vertical PCB D1, plastic nose, with nut and washer, with tip and ring normalling contacts
RJ3VI-S	1/4" TRS Jack, with solder lugs, plastic nose, with nut and washer, no normalling contacts
RJ5VI-S	1/4" TRS Jack, with solder lugs, plastic nose, with nut and washer, with tip and ring normalling contacts

Ordering Key

W/o SUFFIX:



"-D1":



"-S":



Specification

Electrical

Rated current per contact	3 A
Contact resistance	< 10 mΩ
Insulation resistance	≥ 1 GΩ
Dielectric strength	500 V dc

Mechanical

Lifetime	> 1'000 mating cycles
Insertion / withdrawal force	≤ 20 N / ≥ 10 N

Material

Contacts	CuSn6
Contact plating	Ag
Shell (housing)	PA6 30% GR
Thread nose	ZnAl4Cu1

Environment

Operating temperature	-20°C to +70°C
Solderability	complies with IEC68-2-20

1 / 4 " J a c k s

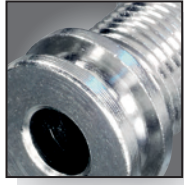
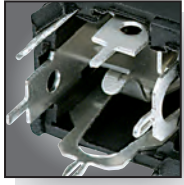

1/4" Phone Jacks



NYS 216
Horizontal Jack



NYS 2202
Long Bushing



NYS 230
Open Jack

- Robust and reliable jacks in metal or plastic housing
- Horizontal and vertical PCB-mount
- Extra long-threaded bushing for thick panel and guitar bodies
- Plastic nut or chrome ferrule nut
- Kinked solder pins secure jack to PCB

NYS 220

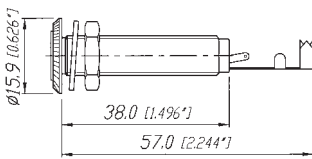

NYS 221

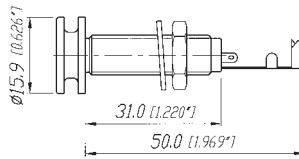

NYS 2162

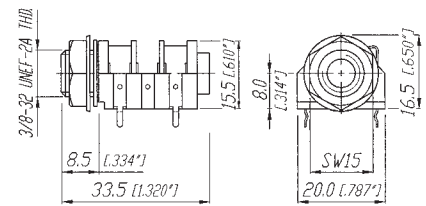

NYS 230

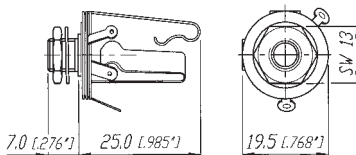

NYS 232

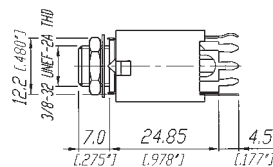

Ordering Information

Type No.	Mono 2 pole	Stereo 3 pole	Description	Distance to PCB
1/4" long bushing jacks				
NYS 2202	•		Jack for thick panels, long-threaded bushing with washer and nut, full metal	–
NYS 2203		•	Jack for thick panels, long-threaded bushing with washer and nut, full metal	–
NYS 221		•	Jack with special design head for guitar strap, for thick panels, long-threaded bushing with washer and nut, full metal	–
1/4" horizontal jacks (all contacts switched)				
NYS 212		•	Plastic housing with washer and nut, solder tap version	–
NYS 2122	•		Plastic housing with washer and nut, solder tap version	–
NYS 215		•	With chrome ferrule nut	8.2 mm
NYS 2152	•		With chrome ferrule nut	8.2 mm
NYS 2152G	•		With chrome ferrule nut and gold contacts	8.2 mm
NYS2152G-DHU	•		Solder tap version with chrome ferrule nut, gold contacts, bulk packaging	–
NYS 216		•	Plastic housing with washer and nut	8.2 mm
NYS 216H		•	Plastic housing with washer and nut, half threaded nose	8.2 mm
NYS 2162	•		Plastic housing with washer and nut	8.2 mm
NYS 2162H	•		Plastic housing with washer and nut, half threaded nose	8.2 mm
NYS 216G		•	With gold contact	8.2 mm
NYS 218		•	With extra long contacts	15.0 mm
NYS 2182	•		With extra long contacts	15.0 mm
NYS 219		•	With long contacts	12.5 mm
NYS 2192	•		With long contacts	12.5 mm
1/4" open jacks				
NYS 229	•		2 contacts, with washer and nut, panel thickness 3.5 mm	–
NYS 229L	•		2 contacts, with longer threaded nose, washer and nut, panel thickness 6.5 mm, with 0.205" faston tabs	–
NYS 230		•	3 contacts, with washer and nut, panel thickness 3.5 mm	–
1/4" vertical jacks				
NYS 232		•	Plastic housing, metal washer and nut, with tip and ring normalling contacts	24.85 mm

Specification

Phone jacks

Electrical	
Rated current	depends on mating connector
Contact resistance	depends on mating connector
Insulation resistance	≥ 1 GΩ
Dielectric strength	500 V dc
Mechanical	
Lifetime	> 1'000 mating cycles
Insertion / withdrawal force	≤ 20 N / ≥ 10 N
Solderability	complies with IEC68-2-20
Operating temperature	-20°C to +70°C
Material	
Housing / handle	Brass Ni / Thermoplastic
Insulation	Thermoplastic
Contacts	Brass, SnCe / Au plated

1 / 4 " P l u g s

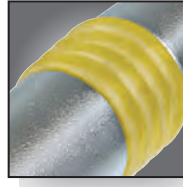
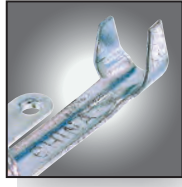
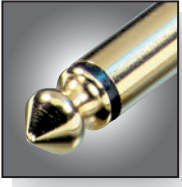

1/4" Phone Plugs



NYS 204



NYS 208



NYS 224G



NYS 224C-6

- Commercial 1/4" plugs and adapters
- All connectors according to EIA RS-453 / IEC 60603-11
- Short and long metal handles
- Plastic handle with flexible strain relief
- Heavy duty cable clamp for best strain relief

- Available with nickel, gold and black plating
- Large cable outlet and solder tabs
- Right angle version
- "Silent switch" on plug finger helps eliminate "pop" during insertion and withdrawal

NYS 201

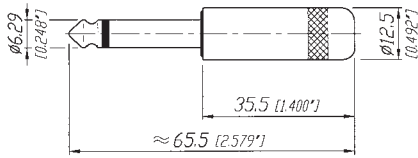

NYS 204

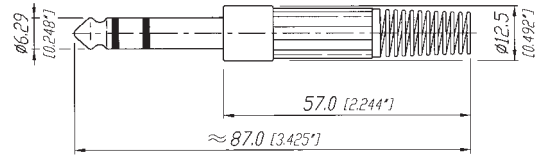

NYS 224

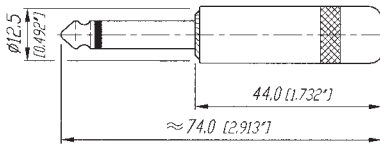

NYS 225

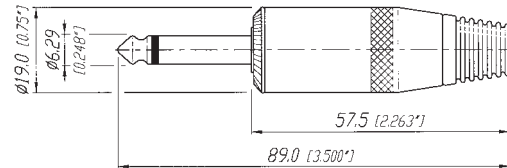

Part number coding: B black handle G gold plated contacts AG all gold, gold plated contacts and shell
 BG ... black handle, gold plated contacts S silent switch GT gold plated tip contact

Ordering Information

Type No.	Mono 2 pole	Stereo 3 pole	Description	Cable O.D.
1/4" plugs short handle				
NYS 201	•		Short turned metal handle	6 mm
NYS 201L	•		With large cable outlet	7.5 mm
NYS 202		•	Short turned metal handle	6 mm
NYS 202L		•	With large cable outlet	7.5 mm
1/4" plugs plastic handle				
NYS 203	•		Plastic handle with flexible strain relief	6 mm
NYS 204		•	Plastic handle with flexible strain relief	6 mm
1/4" plugs right angle				
NYS 207	•		Metal housing, plastic bushing	6 mm
NYS 207-2	•		Metal housing, red cover & plastic bushing	6 mm
NYS 208		•	Metal housing, plastic bushing	6 mm
1/4" plugs long handle				
NYS 224	•		Long polished diecast handle	6 mm
NYS 224AG	•		With gold plated handle and contacts	6 mm
NYS 224BG	•		With black metal handle, gold plated contacts	6 mm
NYS 224G	•		With gold plated contacts	6 mm
NYS 224GT	•		With gold plated tip contact	6 mm
NYS 224L	•		With large cable outlet	8 mm
NYS 224S	•		With tip switched to ground if not inserted (silent)	6 mm
NYS 224C-*	•		Diecast handle with coloured coding ring & rubber flex relief	6 mm
NYS 228		•	Stereo version of NYS 224	6 mm
NYS 228BG		•	With black metal handle, gold plated contacts	6 mm
NYS 228G		•	With gold plated contacts	6 mm
NYS 228GT		•	With gold plated tip contact	6 mm
*) 0 - black, 2 - red, 4 - yellow, 5 - green, 6 - blue				
1/4" plugs with large shell for speaker cables				
NYS 225	•		Large metal handle, rubber bushing	8 mm
NYS 225B	•		With black metal handle	8 mm
NYS 225L	•		With large cable outlet	9 mm
NYS 225S	•		With tip switched to ground if not inserted (silent)	8 mm

Specification

Phone
plugs

Electrical	
Rated current and contact resistance	depends on mating connector
Insulation resistance	≥ 1 GΩ
Dielectric strength	500 V dc
Mechanical	
Lifetime	1'000 mating cycles
Solderability	complies with IEC68-2-20
Operating temperature	-20°C to +70°C
Material	
Housing / handle	Zinc Diecast, Ni / Au / black plated • (NYS 203 / 204 ABS)
Insulation	Thermoplastic
Contacts	Brass, Ni / Au plated
Strain relief	Crimp type SnCe plated

Plugs

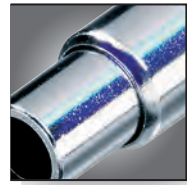
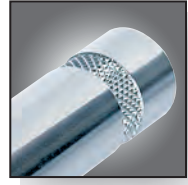

3.5 mm Phone Plugs

Cable Jacks & Adapters



NYS 226



NYS 231BG



NYS 2202P
Cable jack



NYS 240
Cable jack



NYS 236
Phone jack adapter

- Commercial 3.5 mm plugs
- All connectors according to EIA RS-453 / IEC 60603-11
- Heavy duty cable clamp for best strain relief
- Available with nickel and black plating
- Large cable outlet available

- Robust and reliable jacks (1/4" and 3.5 mm) in metal housing
- Heavy duty cable clamp
- Available with nickel and black plating
- 1/4" adapters to interconnect mono & stereo lines

NYS 231

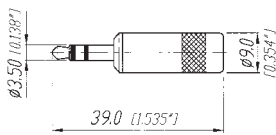

NYS 2202P

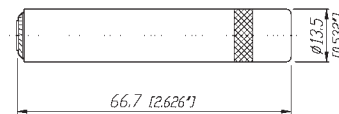

NYS 237

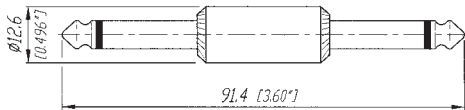

NYS 240

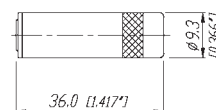

Ordering Information

Type No.	Mono 2 pole	Stereo 3 pole	Description	Cable O.D.
1/4" plug & jack adapters				
NYS 237	•		Mono plug adapter to mate standard 1/4" jacks, full metal	–
NYS 239		•	Stereo plug adapter to mate standard 1/4" jacks, full metal	–
NYS 236	•		Mono jack adapter to mate standard 1/4" plugs, full metal	–
NYS 238		•	Stereo jack adapter to mate standard 1/4" plugs, full metal	–
3.5 mm plugs				
NYS 226	•		Metal handle with crimp strain relief	4 mm
NYS 226B	•		With black metal handle	4 mm
NYS 226BG	•		With black metal handle, gold plated contacts	4 mm
NYS 226G	•		With gold plated contacts	4 mm
NYS 226L	•		With large cable outlet	6 mm
NYS 227		•	3.5 mm plug to 1/4" stereo jack adapter, all metal	–
NYS 231		•	Metal handle with crimp strain relief	4 mm
NYS 231B		•	With black metal handle	4 mm
NYS 231BG		•	With black metal handle, gold plated contacts	4 mm
NYS 231G		•	With gold plated contacts	4 mm
NYS 231L		•	With large cable outlet	6 mm
NYS 231LBG		•	With large cable outlet, black metal handle, gold plated contacts	6 mm
NYS 231LL		•	With x-large cable outlet	8 mm
NYS 231BG-LL		•	With x-large cable outlet, black metal handle, gold plated contacts	8 mm
Cable jacks				
NYS 2202P	•		1/4" mono cable jack with metal handle	6 mm
NYS 2203P		•	1/4" stereo cable jack with metal handle	6 mm
NYS 240		•	3.5 mm stereo cable jack with metal handle	4 mm
NYS 240BG		•	With black metal handle, gold plated contacts	4 mm
NYS 240L		•	With large cable outlet	6 mm

Specification

Cable Jacks & 3.5 mm plugs

Adapters

Electrical			
Rated current	depends on mating connector	depends on mating connector	
Contact resistance	depends on mating connector	depends on mating connector	
Insulation resistance	≥ 1 GΩ	≥ 1 GΩ	
Dielectric strength	500 V dc	500 V dc	
Mechanical			
Lifetime	1'000 mating cycles	1'000 mating cycles	
Solderability	complies with IEC68-2-20	complies with IEC68-2-20	
Insertion / withdrawal force	≤ 20 N / ≥ 10 N	complies with IEC68-2-20	
Operating temperature	-25°C to +70°C	-25°C to +70°C	
Material			
Housing / handle - Zinc Diecast Ni/Au/black plated - Brass, Ni/black plated	3.5 mm plugs cable jacks	• –	
Insulation	Thermoplastic	Thermoplastic	
Contacts	Brass, Ni / Au plated	Brass, Ni / Au plated	
Strain relief	Crimp type SnCe plated	–	
Part number coding:	B black handle BG ... black handle, gold plated contacts	G gold plated contacts S silent switch	AG all gold, gold plated contacts and shell GT gold plated tip contact



Phono ("RCA/Cinch")



NYS 352



NYS 354



NYS 355



NYS 373-0

- Heavy duty phono plugs
- All metal
- Cable O.D. up to 7.2 mm
- Cable clamp or chuck type strain relief (NYS373*)
- Phono receptacle for PCB-mounting
- Phono to phono female adapter

NYS 352

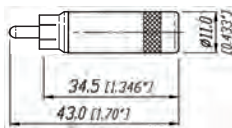

NYS 354

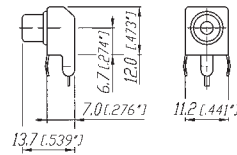

NYS 355

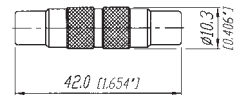

NYS 373-*

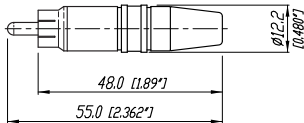

Ordering Information

Type No.	Description	Cable O.D.
Phono ("RCA/Cinch")		
NYS 352	Phono plug	7.2 mm
NYS 352AG	Phono plug, all gold plated	7.2 mm
NYS 352B	Phono plug with black metal handle	7.2 mm
NYS 352BG	Phono plug with gold plated contacts and black metal handle	7.2 mm
NYS 352G	Phono plug with gold plated contacts	7.2 mm
NYS 354	Phono receptacle, PCB-mount, max. panel thickness 1.2 mm	-
NYS 355	Phono to phono female adapter	-
NYS 367-*	Phono chassis mount socket, gold plated contacts, color coding	-
NYS 372P	Phono jack with nickel plated contacts and handle	7.2 mm
NYS 372P-BG	Phono jack with gold plated contacts and black plated handle	7.2 mm
NYS 373-*	Phono plug with gold plated contacts, black chromium shell, chuck type strain relief	3.5 – 6.1 mm

*) 0 - black, 2 - red, 4 - yellow, 5 - green, 6 - blue, 9 - white

Specification

Phono ("RCA/Cinch")

Electrical							
Rated current	depends on mating connector						
Contact resistance	depends on mating connector						
Insulation resistance	≥ 1 GΩ						
Dielectric strength	500 V dc						
Mechanical							
Lifetime	> 1'000 mating cycles						
Solderability	complies with IEC68-2-20						
Operating temperature	-25°C to +70°C						
Material							
Housing / handle	Zinc diecast or Brass Ni / Au / black plated						
Insulation	Thermoplastic						
Contacts	Brass, Ni / Au plated						
Strain relief	- Crimp type SnCe plated • - Chuck tye (POM)						
Part number coding:	<table style="width: 100%; font-size: x-small;"> <tr> <td style="width: 33%;">B black handle</td> <td style="width: 33%;">G gold plated contacts</td> <td style="width: 33%;">AG all gold, gold plated contacts and shell</td> </tr> <tr> <td>BG ... black handle, gold plated contacts</td> <td>S silent switch</td> <td>GT gold plated tip contact</td> </tr> </table>	B black handle	G gold plated contacts	AG all gold, gold plated contacts and shell	BG ... black handle, gold plated contacts	S silent switch	GT gold plated tip contact
B black handle	G gold plated contacts	AG all gold, gold plated contacts and shell					
BG ... black handle, gold plated contacts	S silent switch	GT gold plated tip contact					



DIN Connectors



NYS 321



NYS 325

- Male cable connectors with rugged diecast shell
- Flexible bushing
- Gold or silver plated non-tarnishing contacts
- Heavy duty cable clamp
- Female receptacle, stamped housing
- Complete shielding with ground contact
- Nickel-plated shell

NYS 321

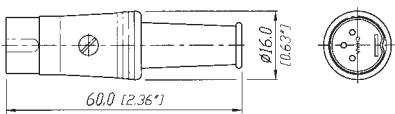

NYS 324

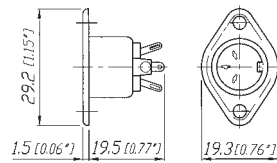

Ordering Information

Type No.	Description	Cable O.D.
DIN male cable connectors		
NYS 321	3 pole, with silver plated contacts	5.0 mm
NYS 321G	3 pole with gold plated contacts	5.0 mm
NYS 322	5 pole, with silver plated contacts	5.0 mm
NYS 322G	5 pole with gold plated contacts	5.0 mm
NYS 322AG	5 pole with gold plated shell and contacts	5.0 mm
NYS 323	7 pole, with silver plated contacts	5.0 mm
NYS 323G	7 pole, with gold plated contacts	5.0 mm
DIN female chassis connectors		
NYS 324	3 pole, with silver plated contacts	-
NYS 325	5 pole, with silver plated contacts	-
NYS 326	7 pole, with silver plated contacts	-

Specification

DIN connectors

Electrical	
Rated current	depends on mating connector
Contact resistance	depends on mating connector
Insulation resistance	≥ 1 GΩ
Dielectric strength	500 V dc
Mechanical	
Lifetime	> 1'000 mating cycles
Cable O.D.	5 mm
Solderability	complies with IEC68-2-20
Operating temperature	-25°C to +70°C
Material	
Housing / handle	- Zinc diecast Ni/Au plated - Steel, Ni plated
Insulation	Thermoplastic
Contacts	Brass, Ni / Au plated
Strain relief	Crimp type Zn plated
Part number coding:	B black handle G.... gold plated contacts AG all gold, gold plated contacts and shell BG ... black handle, gold plated contacts S silent switch GT gold plated tip contact

Patch Box & Stage Boxes



Patch Box



NYS-SSR-8

Stage Boxes



NSB2A-20/4



NSB2B-12/4



NSB1C-8/0

- "The Easy Way to Link your Audio System"
- 1/4" Patch box with 8 send/return moduls (split print)
- Metal housing – reliable and robust
- Easy to assemble, simple to use

- Modular system for individual size and configuration
- Designed to be in an individual combination of connectors for "IN" and "OUT" and length
- Easy to assemble
- 3 pole XLR IDC receptacles eliminate stripping and tinning of wires
- Self-adhesive labels for channel numbering not included. Must be ordered separately.
- Extremely price competitive

NYS SSR-8

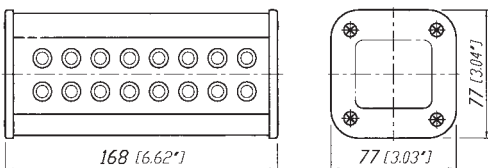

Type A

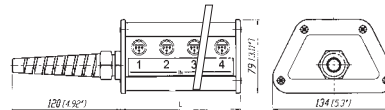

Type A	L
NSB1A	132 (5.2')
NSB2A	252 (9.93')
NSB3A	372 (14.65')
NSB4A	491 (19.33')

Type B

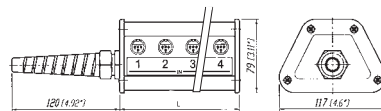

Type B	L
NSB1B	132 (5.2')
NSB2B	252 (9.93')
NSB3B	372 (14.65')

Type C

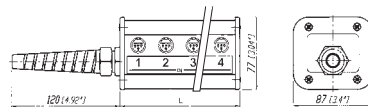

Type C	L
NSB1C	132 (5.2')
NSB2C	252 (9.93')
NSB3C	372 (14.65')

Ordering Information

Patch box

NYS-SSR-8	1/4" patch box with 8 send/return moduls (split print)
-----------	--

Stage boxes – type A

NSB1A-8/4	Length 1, 8 IN (female/send) and 4 OUT (male/return)
NSB2A-12/4	Length 2, 12 IN (female/send) and 4 OUT (male/return)
NSB2A-20/4	Length 2, 20 IN (female/send) and 4 OUT (male/return)
NSB3A-32/4	Length 3, 32 IN (female/send) and 4 OUT (male/return)
NSB4A-40/4	Length 4, 40 IN (female/send) and 4 OUT (male/return)
NSB4A-40/8	Length 4, 40 IN (female/send) and 8 OUT (male/return)

Stage boxes – type B

NSB1B-8/0	Length 1, 8 IN (female/send)
NSB2B-12/4	Length 2, 12 IN (female/send) and 4 OUT (male/return)
NSB2B-16/0	Length 2, 16 IN (female/send)
NSB3B-20/4	Length 3, 20 IN (female/send) and 4 OUT (male/return)

Stage boxes – type C

NSB1C-8/0	Length 1, 8 IN (female/send)
NSB2C-12/4	Length 2, 12 IN (female/send) and 4 OUT (male/return)
NSB3C-20/4	Length 3, 20 IN (female/send) and 4 OUT (male/return)

(Supplied as disassembled set comprising of all hardware parts including plates, profiles, strain relief, endpieces and screws.)

Specification

1/4" patch box

Stage boxes

Electrical

Rated current	depends on mating connector	•	2 A
Contact resistance	depends on mating connector	•	< 5 mΩ
Insulation resistance		≥ 1 GΩ	≥ 1 GΩ
Dielectric strength		500 V dc	500 V dc

Mechanical

Lifetime		> 10'000 mating cycles	> 1'000 mating cycles
Insertion / withdrawal force		≤ 10 N / ≥ 10 N	≤ 10 N / ≥ 10 N
Multicore cable O.D.		–	15/20 mm
Applicable wire size		–	0.22 mm ² / 24 AWG and 0.14 mm ² / 26 AWG
Operating temperature		-25°C to + 70°C	-25°C to + 70°C

Material

Housing		Aluminium	Aluminium
Quad plates		–	POM
End pieces		Thermoplastic	Thermoplastic
Contacts	Brass/Bronze	Ni plated	Au plated
Part number coding:	B black handle BG ... black handle, gold plated contacts	G gold plated contacts S silent switch	AG all gold, gold plated contacts and shell GT gold plated tip contact

Dual Banana Plugs

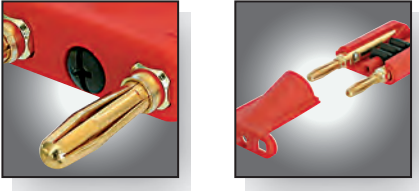

Dual Banana Plugs



NYS 508-R



NYS 508-B

- Cable strain relief: teathed cable clamp featuring cable O.D. 6.0–10.5 mm
- Protection against electric shock: cable ends and plugs are completely covered in mated condition
- Gold plated contacts for tarnish resistance & long insertion life

NYS 508-*

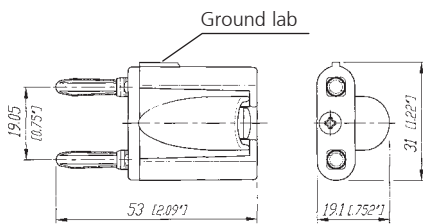

Dual Banana Plugs

Ordering Information

Type No.	Description	Cable O.D.
Dual banana plugs		
NYS 508-R	Dual banana plug, red housing	6.0 – 10.5 mm
NYS 508-B	Dual banana plug, black housing	6.0 – 10.5 mm

Specification

Dual
banana plug

Electrical	
Rated current	20 A
Insulation resistance	$\geq 1 \text{ G}\Omega$
Dielectric strength	500 V dc

Mechanical	
Lifetime	> 1'000 mating cycles
Operating temperature	-25°C to +50°C

Material	
Insulation	Thermoplastic
Contacts	Brass plated
Strain relief	Teethed cable clamp

Part number coding:	B black handle	G.... gold plated contacts	AG all gold, gold plated contacts and shell
	BG ... black handle, gold plated contacts	S silent switch	GT gold plated tip contact

Liechtenstein (Headquarters)

NEUTRIK AG, Im alten Riet 143, 9494 Schaan
T +423 237 24 24, F +423 232 53 93, neutrik@neutrik.com

Germany / Netherlands / Denmark / Austria

Neutrik Vertriebs GmbH, Felix-Wankel-Strasse 1, 85221 Dachau, Germany
T +49 8131 28 08 90, info@neutrik.de

Great Britain

Neutrik (UK) Ltd., Westridge Business Park, Cothey Way
Ryde, Isle of Wight PO33 1 QT
T +44 1983 811 441, sales@neutrik.co.uk

France

Neutrik France SARL, Rue du Parchamp 13, 92100 Boulogne-Billancourt
T +33 1 41 31 67 50, info@neutrik.fr

USA

Neutrik USA Inc., 4115 Taggart Creek Road, Charlotte, North Carolina, 28208
T +1 704 972 30 50, info@neutrikusa.com

Japan

Neutrik Limited, Yusen-Higashinohonbashi-Ekimaie Bldg., 3-7-19
Higashinohonbashi, Chuo-ku, Tokyo 103
T +81 3 3663 47 33, mail@neutrik.co.jp

Hong Kong

Neutrik Hong Kong LTD., Suite 18, 7th Floor Shatin Galleria
Fotan, Shatin
T +852 2687 6055, neutrik@neutrik.com.hk

China

Ningbo Neutrik Trading Co., Ltd., Shiqi Street, Yinxian Road West
Fengjia Villiage, Yinzhou Area, Ningbo, Zhejiang, 315153
T +86 574 88250488 800, neutrik@neutrik.com.cn

India

Neutrik India Pvt. Ltd., Level 3, Neo Vikram, New Link Road,
Above Audi Show Room, Andheri West, Mumbai, 400058
T +91 982 05 43 424, anklesaria@neutrik.com

Associated companies**Contrik AG**

Steinackerstrasse 35, 8902 Urdorf, Switzerland
T +41 44 736 50 10, contrik@contrik.ch

H. Adam GmbH

Felix-Wankel-Straße 1, 85221 Dachau, Germany
T +49 08131 28 08-0, info@adam-gmbh.de

