

# AV Integrating Systems

Delivering complete  
Audio-Visual solutions



# Contents

4	<b>In the Floor</b>	HDMI and 6" and 8" Fire-Rated Poke-Throughs
6	<b>In the Floor</b>	X-END Analog Audio Video and 4" Fire-Rated Poke-Throughs
8	<b>In the Floor</b>	USB and 1394 "Fire Wire" and 4" AV Floor Boxes
10	<b>In the Floor</b>	Pro-AV Style XLR speakON® ¼" Stereo and Large Capacity Floor Boxes
12	<b>In the Table</b>	Hubbell iSTATION HD15 VGA Style Connections and Work Surface Boxes
14	<b>On the Wall</b>	Hubbell iSTATION AV Modules and Frames, Panels and Plates
16	<b>On the Wall</b>	Hubbell iSTATION AV Keystone Connectors and Large Capacity AV Wall Boxes
18	<b>In the Wall</b>	Networking Connections and In-Wall Convergence Boxes
20	<b>In the Ceiling</b>	Ceiling Accessories and AV Ceiling Convergence Boxes
22	<b>On the Surface</b>	Hubbell iSTATION Connection Plates and Surface Mount Raceway
24	<b>In the Rack</b>	Loaded and Configurable Patch Panels and Equipment Racks
26	<b>In the Cabinet</b>	Cabinet Accessories and Power and Remote Equipment Cabinets

# Integrating AV Systems

Today's business environment relies on the use of multimedia every day. Accessing and viewing video has become as vital as receiving email. Hubbell's iSTATION Connectivity products and Delivery Systems solutions are multi-patented product offerings designed to address each user's expectations, focusing on growing audio video needs.

Hubbell's main focus is the integration of connections from multimedia devices and applications such as display devices, white boards, video-conferencing, webcasting and streaming media content into a user friendly interface. Hubbell recognizes that having the right AV connection in the right location is important to providing the flexibility to easily connect and disconnect various devices.

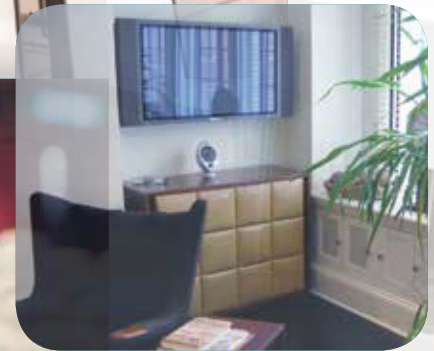

Hubbell's breadth of connections and delivery products provide a consistent and practical solution for deploying all types of multimedia applications. Whether it's on a wall, in the floor, in the ceiling, on a desk, in a conference table or in a rack, Hubbell's AV integrated systems approach is straightforward and user-friendly. It becomes effortless to add connectors and maintain a uniform look across all systems, delivering the exact configuration needed for the application.

# Through the Floor

Meeting the needs of larger AV and data deployments, Hubbell's large capacity recessed 6" and 8" SystemOne Fire-Rated Poke-Throughs offer increased capacity, accommodating power, data and AV within the same space. Recessed FRPTs enhance functionality by effectively supporting multiple HDMI and AV connections in numerous configurations.

## AV Application: HDMI



### HDBASE-T HDMI EXTENDER

- Extend HDMI, USB, RS232 and IR up to 328 feet over UTP
- High definition digital 4K video and audio with control
- 110 termination reduces installation time



**TIP:** Category 6A or higher cables recommended for 4K support.

### HDMI 110 VIDEO EXTENDER 2-U MODULE

- **Flexibility:** Locate a display up to 147 feet away using two UTP category cables
- **Integration:** Easily snaps into Hubbell's array of workstation and delivery products



### HDMI KEYSTONE FEED THROUGH COUPLER

- **Small form factor:** Simple configuration integration
- **Compatibility:** Easily installs into standard Hubbell keystone openings, allowing for additional connectors to be configured



### HDMI FEED THROUGH MODULE COUPLERS

- **Capacity:** Four-inch application tail provides ease-of-use behind the plate where capacity issues occur
- **Reliability:** Locking in-wall interface for secure connection stability



### HDMI PATCH CORDS AND HORIZONTAL ASSEMBLIES

- **Configuration:** Multiple configuration styles for different applications
- **Standards:** HDMI Category 2 Cabling, 24 AWG (12-Meter Channel)



**Delivery Application:  
6" and 8" Fire-Rated Poke-Throughs (FRPT)**



**HUBBELL SYSTEMONE 6" AND 8" RECESSED SERVICE FRPTS**

**6-Inch Recessed FRPT**

- Offers two unique device plate layouts for maximum AV capacity
- Adjustable plate depths for increased multimedia installation flexibility

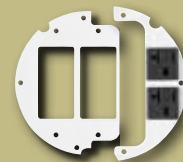

60/40 split  
Sub-Plates

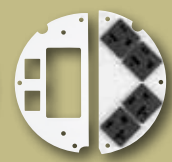

50/50 split  
Sub-Plates

**8-Inch Recessed FRPT**

- Comes standard with conduit connection stubs
- Compatible with third party AV devices
- Standard NEMA device spacing

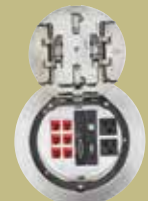

**Low Profile Cover in Five Finishes**

- Brushed aluminum
- Satin nickel plated
- Brushed brass plated
- Bronze plated finish
- Black powder coat



# In the Floor

When applications need to penetrate the floor, Hubbell SystemOne 4" flush service Fire-Rated AV Poke-Throughs allow users to define and customize hundreds of configurations utilizing 20+ different sub-plates styles. X-END can easily adapt to different sub-plates with the flexibility of the patented modular connections and configurations.



## X-END AV SYSTEM

- Patented plug-n-play X-END AV System
- Eliminates field termination on the job site
- Horizontal runs manufactured in plenum and non-plenum configurations
- Can utilize same cabling infrastructure for multiple applications



**TIP:** Always design in extra capacity behind plate for termination

## AV Application: X-END Analog Audio Video

### X-END PATCH CORDS AND TAILS

- **Versatility:** Allows the user to swap out application patch cords and tails without changing the horizontal runs
- **Reliability:** Locking interface ensures mated connection



### X-END CONNECTORS

- **Superior strain relief:** Over molded connections protect cable and connectors during and after installation
- **Capacity:** Allows up to 6 keystone connections or three 1-unit modules in a single gang, delivering a maximum of 30 connectors in a single plate



### X-END ISATION MODULES

- **Simplicity:** X-END plug-n-play feature saves valuable installation and testing time in the field
- **Flexibility:** Supports multiple applications and connector configurations



### X-END HORIZONTAL ASSEMBLIES

- **Small form factor:** X-END horizontal cable runs can easily be pulled through 3/4" conduit without any issue
- **Performance:** Custom AV cable is designed for minimal signal loss, delivering transparent video and flawless audio



**Delivery Application:  
4" Fire-Rated Poke-Throughs (FRPT)**



**HUBBELL SYSTEMONE  
4" FLUSH SERVICE FRPTS**

**High Capacity 4" Core Hole**

- Largest available AV conduit offering at 1½" in a 4" core hole
- Up to 12 AV/data keystone connectors
- High capacity furniture feed to distribute point-to-point AV and network connections



**Dual Service Available**

- Hubbell iSTATION compatible
- Includes pre-wired receptacles
- ADA compliant flange height

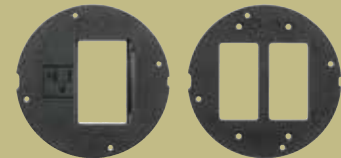

**Universal Covers and Sub-Plates**

- Universal covers that fit both FRPTs and floor boxes allow for common décor throughout a building
- Options for carpet or tile:
  - Black
  - Aluminum
  - Brass
  - Gray
  - Ivory



# In the Floor

Accommodating AV applications on grade is simple with Hubbell SystemOne floor boxes. These innovative floor boxes can customize multimedia deployments by utilizing easy to configure sub-plates. USB connections can simply be added to allow for device-to-device communication and programming without configuration limitations.

## AV Application: USB and 1394 "Fire Wire"

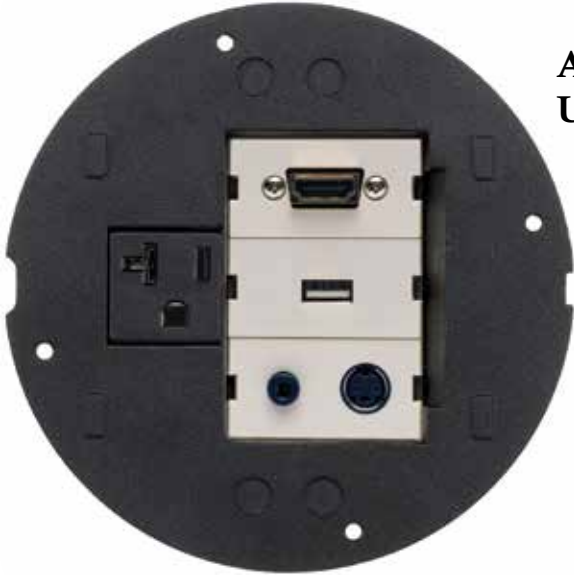

### INTEGRATING USB CONNECTIONS

- Provide a perfect solution for extending controls or peripherals from device to device
- Standard 1-unit iSTATION module, designed to fit in plates, panels, raceway, SystemOne and various delivery systems products
- Available as keystone, Pro-AV D-sub style and iSTATION 1-U modules



**TIP:** When installing feed through couplers, always allow space behind the plate for cable bend radius.

### USB 110 EXTENDER iSTATION 1-U MODULE

- **Compatibility:** Extends any USB 2.0 full speed device up to 100 feet using standard category rated cable (UTP)
- **Installation:** Requires no external power adapter



### USB 3.0 KEYSTONE FEED-THROUGH COUPLERS

- **Flexibility:** Universal reversible keystone A and B design fits into all Hubbell products
- **Application:** External hard drives, webcams, multi-channel audio interface and Blu-ray burners



### USB 2.0 KEYSTONE FEED-THROUGH COUPLERS

- **Standards:** USB 2.0 Performance 480 Mbit/s
- **Versatility:** Ideal to remotely control devices such as white boards, projectors or flat panel monitors



### iSTATION PRO-AV USB 2.0 AND 1394

- **Integration:** Pro-AV Series installs into a 1.5U iSTATION module for seamless connector configuration
- **Form factor:** Standard Pro-Audio D-style foot print





## Delivery Application: 4" AV Floor Boxes

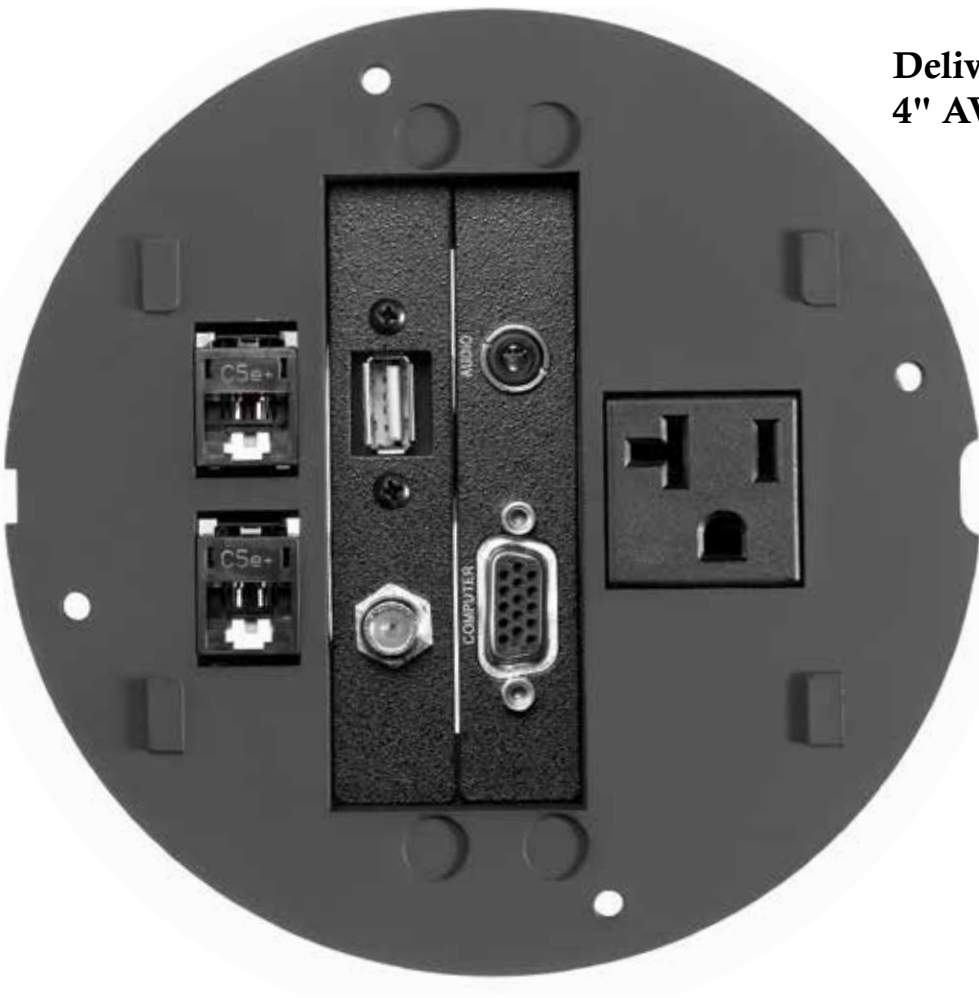

### HUBBELL SYSTEMONE FLUSH SERVICE FLOOR BOXES

#### Multimedia Compatible

- Dual service capacity
- Designed for high cable capacity and a larger bend radius
- 1 1/2" threaded hub, standard
- Corrosion resistant for on grade applications

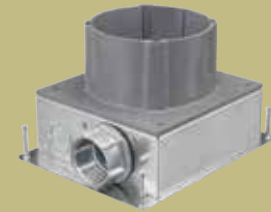

#### Flexible Installation

- Simple saw cut leveling
- Low voltage partition included
- Wide variety of mounting plate options
- Floor box options include stamped steel, cast iron and non-metallic



#### Universal Covers and Sub-Plates

- Universal covers that fit both FRPTs and floor boxes allow for common décor throughout a building
- Sub-plates for third party devices
- Options for carpet or tile:
  - Black
  - Aluminum
  - Brass
  - Gray
  - Ivory



# In the Floor

The CFB series floor boxes are the ideal solution for hospitality, entertainment, conference and training rooms. These Boxes deliver flexibility and maximum capacity for any Audio/Video installations. Providing 11 gangs to populate, this floor box is the ultimate in capacity allowing for standard Pro-Audio XLR type connections to be mounted alongside various services.



## AV Application: Pro-AV Style, XLR, speakON®, 1/4" Stereo

### HUBBELL iSTATION PRO-AV SYSTEM

- Connectors easily install into 1.5U iSTATION module for seamless delivery integration
- Perfect solution to connect professional and commercial grade audio components
- Universally accepted standard Pro-AV D-style housing provides installation compatibility with industry standard D-mounting dimensions



**TIP:** IEC 60 268-12 defines wiring of XLR connectors

**Pin 1** → Xternal of cable (shield/ground)

**Pin 2** → Live ("Hot"/+ polarity)

**Pin 3** → Return ("Cold"/- polarity)

### Pro-AV XLR 3-POLE SCREW TERMINAL

- **Installation:** Fast and easy screw terminal termination accommodating wire range (AWG 26 -20)
- **Application:** Perfect solution to connect a microphone to professional grade AV equipment



### Pro-AV XLR 3-POLE SOLDER TYPE

- **Reliability:** High performance 3-pole balanced solder type termination
- **Immunity:** Rugged all metal housing offers best overall RF protection and electromagnetic shielding



### Pro-AV 1/4" LOCKING STEREO JACK

- **Security:** Plug locks-in automatically when mating and unlocks by pressing release tab
- **Compatibility:** Mates with all mono and stereo plugs specified acc. EIA RS-453 (A-gauge)



### Pro-AV 2-POLE speakON®

- **Dependability:** Glass reinforced; extremely robust and reliable Twist-Lock® style latching system
- **Flexibility:** Mates with both speakON® and 1/4" connectors offering a greater option of interconnections



speakON® is a registered trademark of NEUTRIK AG.

**Delivery Application:  
Large Capacity Floor Boxes**

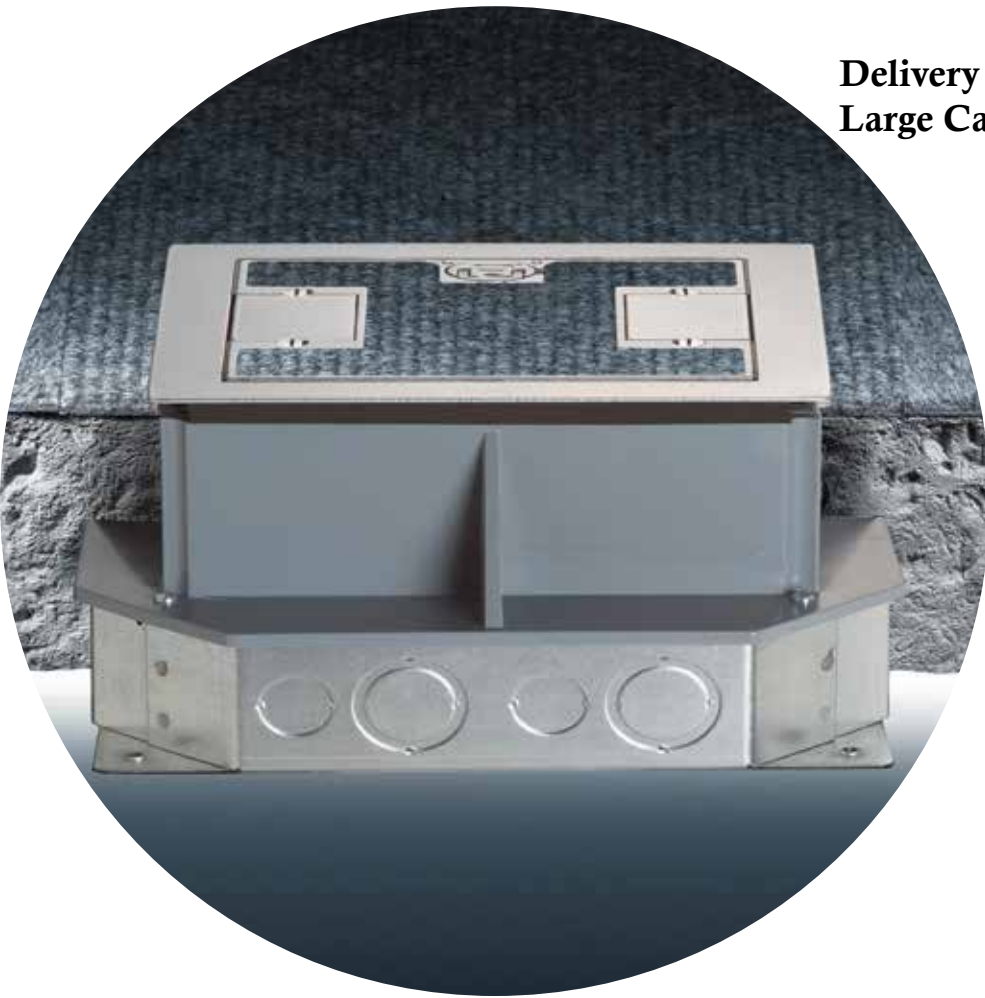

**LARGE CAPACITY FLOOR BOXES**

**LCFB Series**

- 6 device capacity with rectangular or round covers
- Recessed connections protect expensive active components
- Removable wireways for easy cable pulls



**CFB Series**

- 3<sup>3</sup>/<sub>4</sub>" of space behind faceplates for active modules
- Accepts industry standard wall plates
- 2" knock outs
- 7, 8 or 11 device capacity
- Standard NEMA plate spacing



**CFB8 Series**

- 20,000lb cover load rating with 2x safety factor (40,000lb)
- 8 gangs of connectivity
- Twelve 1", 1 1/4", 1 1/2" concentric knockouts
- Individual or multi-gang pass throughs



# In the Table

AV integration into a workstation or table top is easy using Hubbell's Work Surface Series products. Its open architecture design allows for both analog (VGA), digital (HDMI) keystone and Hubbell iSTATION connectivity to be configured, making them a perfect solution for work stations, hospitality, training facilities, conference rooms and podiums.



## VGA STYLE CONNECTIONS

- Hubbell One design provides ease-of-use for compatibility and integration
- Provides transparent analog video distribution
- Multiple VGA Style configurations support different installation requirements
- VGA front-mount connector simplifies running a VGA style application into a standard keystone face plate

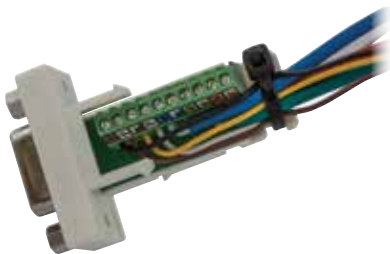

**TIP:** When terminating a screw terminal connector, always measure and strip cable prior to termination.

## AV Application: Hubbell iSTATION HD15 VGA Style 15-Pin Connections

### KEYSTONE SCREW TERMINAL

- **Innovation:** Industry's first front loading high-density DB15 VGA style connection
- **Termination:** Screw terminal eliminates the need for crimping and soldering in the field saving valuable time



### KEYSTONE SCREW TERMINAL

- **Installation:** Aids in running a VGA style application when depth and capacity are an issue
- **Application:** Recommended maximum cable distance:
  - 100 ft. resolution: 800 x 600
  - 75 ft. resolution: 1224 x 768
  - 50 ft. resolution: 1280 x 1024



### 90° GENDER CHANGER

- **Solution:** Solves connector depth issues in raceway and other delivery applications where depth is an issue
- **Integration:** Mounts into all Hubbell iSTATION plates and frames



### X-END PLUG-N-PLAY

- **Time Savings:** Easy plug-n-play installation, zero termination
- **Reliability:** Over-molding provides connector strain relief behind the plate



**Delivery Application:  
Furniture and Work Surface Boxes**



**WORK SURFACE BOXES**

**Applications**

- Ideal for use in board rooms, training facilities, conference rooms and podiums
- Available in single and dual-service configurations



**Functional Designs**

- Open architecture design
- Pre wired options available
- Multiple finish options to match any style or décor
- Available in multiple capacities



**Easy Integration**

- Integrates with keystone connectors and iSTATION modules for AV and multi-media solutions
- Several profile options offer power and low-voltage services, depending on the application



# On the Wall

Hubbell iSTATION products provide a consistent and practical solution, allowing the integration of AV services in various configurations and delivery system products located where needed. The iSTATION system approach makes adding a connection effortless while maintaining a clean, uniform look.



## AV Application: Hubbell iSTATION AV Modules

### CONFIGURABLE MODULES

- **Numerous options:** Various styles and configurations allow the user to design each plate to the specific application
- **Flexibility:** Easily add any Hubbell keystone AV, data or fiber connection to any configuration

### LOADED MODULES

- **Reliability:** Loaded with high quality connectors for easy installation and configurability
- **Capacity:** Loaded high-density modules expand connector options and allow new applications to be added in a snap

### 110 UTP MODULES

- **Labor savings:** Save time and money on the job site utilizing standard UTP for termination
- **Applications:** HDMI, USB, component, composite, 3.5mm, VGA, stereo audio and S-video

### SPECIALTY MODULES

- **Integration:** Custom high-density application loaded and unloaded specific modules
- **Form factor:** Designed to capture standard applications in 1-, 1.5- and 2-unit footprints



### HUBBELL iSTATION AV SYSTEM

- Allows up to 6 keystone connections or 3 1-unit module combinations in a single gang, delivering maximum connections
- Supports multiple applications and connector configurations
- Integrates directly into all Hubbell SystemOne products
- Active and non-active modules

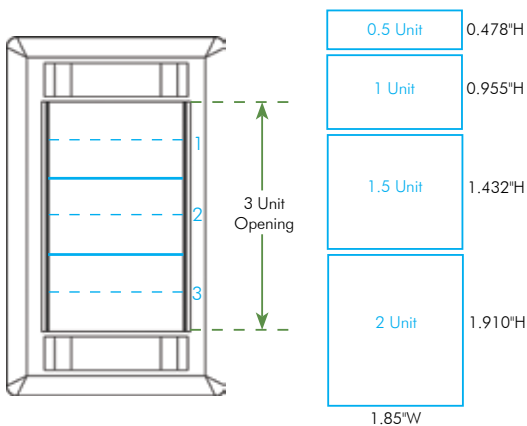

**TIP:** Hubbell iSTATION frames accept three units of module combinations in a single-gang opening; lay out configurations before ordering.

## Delivery Application: Hubbell iSTATION Frames, Panels and Plates



### MODULAR SYSTEMS

#### Multimedia

- Integrates into all delivery options
- Ideal for customizing and configuring any AV application



#### Delivery Options

- 1-, 2-, 3- and 4-gang stainless steel face plates
- 1- and 2-gang face plates
- 4", 6" and 8" poke-throughs
- Table top boxes
- Raceway frames



#### In-Rack Applications

- 1-RMU (8 1-U iStation Modules)
- 2-RMU (24 1-U iStation Modules or 3-U 8 Gangs)
- Angled versions eliminate the need for horizontal cable management



# In the Wall

The Large Capacity AV Multi-Service Wall Boxes are the ideal solution for applications requiring AV, data, power and building automation (BAC) to reside side-by-side in the same box. The versatility of the box incorporates concentric 3/4"-2" knockouts and large capacity volume (3 1/4" depth), allowing for pre-connectorized AV, Category 6A and fiber cables to be installed without issues.



## HUBBELL iSTATION KEYSTONE CONNECTIONS

- Supports multiple applications and connector configurations
- Customizing a multimedia outlet is as simple as snapping in an iSTATION keystone connector in any frame, plate or module alongside any loaded module or category rated jack
- iSTATION keystone connectors fit into all delivery products which include: poke-throughs, floor boxes, furniture boxes, raceway, wall boxes and face plates



**TIP:** When adding a coupler to configurations always check the depth behind the plate/frame for proper bend radius and fit.

## AV Application: Hubbell iSTATION AV Keystone Connectors

### 3.5MM STEREO JACKS

- **Termination:** Solder, feed through, 110 UTP and screw terminal
- **Configurable:** Easy to add a 3.5mm stereo connection to any design



### F-CONNECTORS

- **Application:** Recessed for flush mounting applications in high traffic areas and poke-throughs
- **Performance:** Gold 3GHZ for high bandwidth applications



### RCA CONNECTIONS

- **Installation:** Solder, feed through, flush mount, 110 UTP and screw terminal
- **Ease of use:** Add an RCA audio or video connection to any design



### AV AND DATA COUPLERS

- **Form factor:** HDMI 1.4 high density couplers extend true HD 1080p video signal to any display device
- **Integration:** Feed-through USB/data couplers for extending control, video and extended data devices





## Delivery Application: Large Capacity AV Wall Boxes



### LARGE CAPACITY WALL BOXES

#### Customizable

- Designed for large capacity AV/data installation
- Capacity:
  - 2-gang (66.7 cubic inches)
  - 3-gang (113.3 cubic inches)



#### Accommodating Design

- Utilizes standard NEMA size wallplates
- Concentric 2-inch knockouts for AV cabling
- UL listed low voltage partition
- 3¼" deep boxes accommodate large capacity AV/data intensive installs



#### Easy Installation

- Three raised ground screws
- 1-, 2- or 3-gang wiring capacity; mud ring defines number of gangs
- 3-gang includes built-in stud mounting brackets and spanner straps



# In the Wall

Flat Panel Television (FPTV) boxes offer an easy and flexible means for mounting equipment and organizing connections for any size installation—all in one box. When deploying digital signage and flat panel displays to the network, simply add a category rated 6/6A high-performance Ethernet connection to the configuration.



## AV Application: Networking Connections

### CATEGORY RATED CONNECTORS

- Third party verified TIA category component compliant
- Exclusive 1-punch termination reduces termination time by 75%
- True network application assurance
- PoE and PoE+ ready
- Hubbell standard keystone format



**TIP:** Always allow for bend radius behind and inside furniture and walls for optimum transmission.

### CATEGORY 6A UTP RJ45 JACKS

- **Performance:** High bandwidth 10 gigabit Ethernet applications
- **Strain relief:** Locking IDC stuffer cap secures wires to ensure complete termination retention



### CATEGORY 6A FTP RJ45 JACKS

- **Application:** True 10GbE and PoE+ application assurance
- **Interoperable:** Works with current industry standard Category 6/6A shielded AV systems



### CATEGORY 6 AND 5e UTP RJ45 JACKS

- **Labor savings:** 1-punch tool terminates all Xcelerator Jacks within seconds
- **Consistency:** IDC tower's blade feature assists in pair splitting during termination, maintaining cable twist integrity to the point of termination



### FIBER CONNECTIONS LC, SC AND ST

- **Compatibility:** Connectors interface with all fiber audio video extenders and matrix switches
- **Options:** Wide variety of colors, available in different mounting styles and sleeve options



**Delivery Application:  
In-Wall Convergence Boxes**

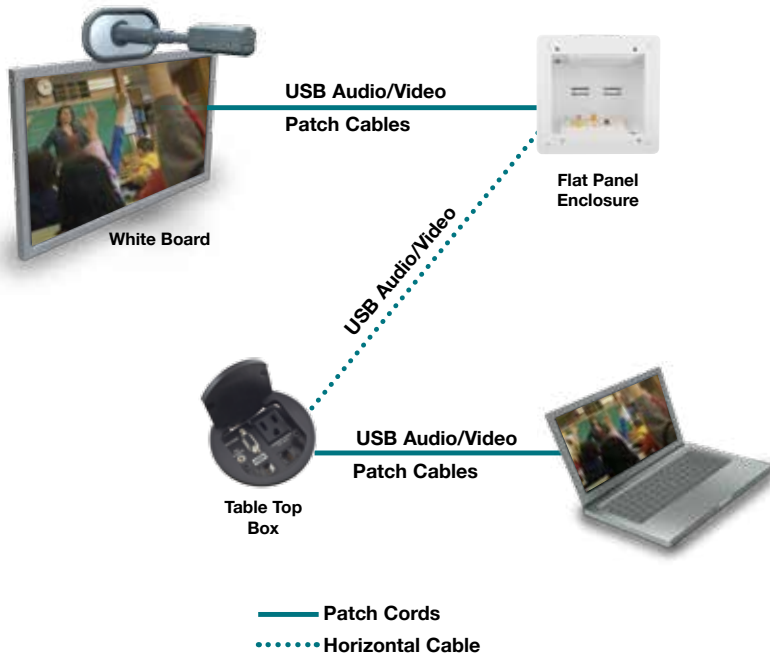

**FLAT PANEL ENCLOSURES**

**Flexibility**

- High density delivery of power, data, and AV
- New or retrofit mounting flexibility
- Easily reconfigured to adapt to new applications



**Features**

- 2-gang steel enclosure with 1½" and 1¼" conduit knockouts support typical displays
- Larger steel 10", 14", and 28" high in-wall enclosures support equipment and connections for advanced applications
- Integrated trim rings quickly clean up sheetrock rough-in



**Accessories**

- Networking and AV distribution modules provide logical connection management
- Cabinet mounted receptacle kits provide convenient power to the enclosure, available in surge and standard kits



# In the Ceiling

Distributing the right AV connections to a projector in a plenum or non-plenum environment is simple using Hubbell's AV ceiling box. These boxes mount into the ceiling grid and provide enough space for active and non-active AV gear, power connections and cable storage and management.



## AV Application: Ceiling Accessories

### THERMOSTAT AND FAN

- **Air flow:** Where heat is an issue, the fan will quietly pull the warm air out of the cabinet and exhaust it outside
- **Heat control:** Programmable thermostat allows user to adjust temperature to the environment



### VELCRO® PRODUCTS

- **Options:** Various lengths and sizes for organizing and managing cables efficiently
- **Equipment mounting:** Simple solution for securing active devices whenever and wherever needed



### HDMI 1.4 SPECIALTY MODULES

- **Flexibility:** Ease-of-use for installations that have depth and capacity issues
- **High density:** The tails small form factor foot print allows for two connections in a single gang faceplate



### POWER KITS

- **Protection:** Safeguard active equipment with a quality surge protected power kit
- **Kit contents:** A Hubbell surge-protected duplex receptacle with audible alarm (HBL5262IS), single-gang work box, 6' POLYTUFF® non-metallic conduit, stainless steel face plate, and assembly hardware kit



### CEILING INTEGRATION

- Designed for AV convergence in the ceiling for signal routing to projectors and white boarding devices
- Power, data and active AV devices in the ceiling
- Installs into standard ceiling tile grids available in plenum and non-plenum



**TIP:** Always use VELCRO® to manage cabling inside ceiling boxes to ensure optimized performance.

VELCRO® is a registered trademark of Velcro Industries B.V.

## Delivery Application: AV Ceiling Convergence Boxes



### CEILING ENCLOSURES

#### AV Integration

- Designed for power, data and active AV devices in the ceiling
- Easily installs into a standard 2' ceiling tile grid (2' x 1')
- Manages active AV devices (FSR<sup>®</sup>, Extron<sup>®</sup> and Crestron<sup>®</sup>) for signal routing to projectors



#### Plenum and Non-Plenum

- All steel rugged construction provides the ultimate strength for installation
- Designed to neatly manage multiple applications inside one enclosure
- Loaded with two Hubbell 20A duplex receptacles and a 2-gang back box
- 100% steel construction



#### AV Zone Ceiling Enclosures

- In the ceiling remote cabinet for active equipment and remote patching
- Flexible mounting options
- Rated for plenum environments
- Optimize space utilization



# On the Surface

Hubbell's Metal and Non-Metallic Raceway have been designed to address AV intensive applications and multimedia integration. The Raceway features easy configurability, compliant bend radius corners and fittings, deep boxes to mount Hubbell iSTATION plates for use with AV, fiber and category rated cabling and connections.



## HUBBELL iSTATION PLATES

- Custom configurable AV and data plates, panels and cover plates
- Plates and frames integrate into all delivery products
- Provides consistency across application and delivery configurations
- UL 1863 Listed



**TIP:** Cable through plates provide a simple solution for connecting directly to a device.

## AV Application: Hubbell iSTATION Connection Plates

### REAR LOADING FACE PLATES

- **Integration:** Fits all Hubbell iSTATION keystone connections (AV, data and fiber)
- **Secure:** Plate has to be removed to access connectivity



### FRONT LOADING FACE PLATES

- **Aesthetics:** Plate has adjustable leveling feature and flush mounts to wall with box eliminator
- **Configurability:** Allows for future upgrades and MACs without replacing the frame



### DECORATOR FRAMES AND PLATES

- **Standards:** UL Listed for power and low-voltage with label fields
- **Options:** ISF frames available in various port configurations, colors and connector configurations



### CUSTOMIZED AV PLATES

- **Custom:** Each plate can be customized for room décor, unique wood or wall pattern, labeling, designation, application, etc.
- **Labor Savings:** Plates can be pre-loaded with connections for easy installation



## Delivery Application: Surface Mount Raceway

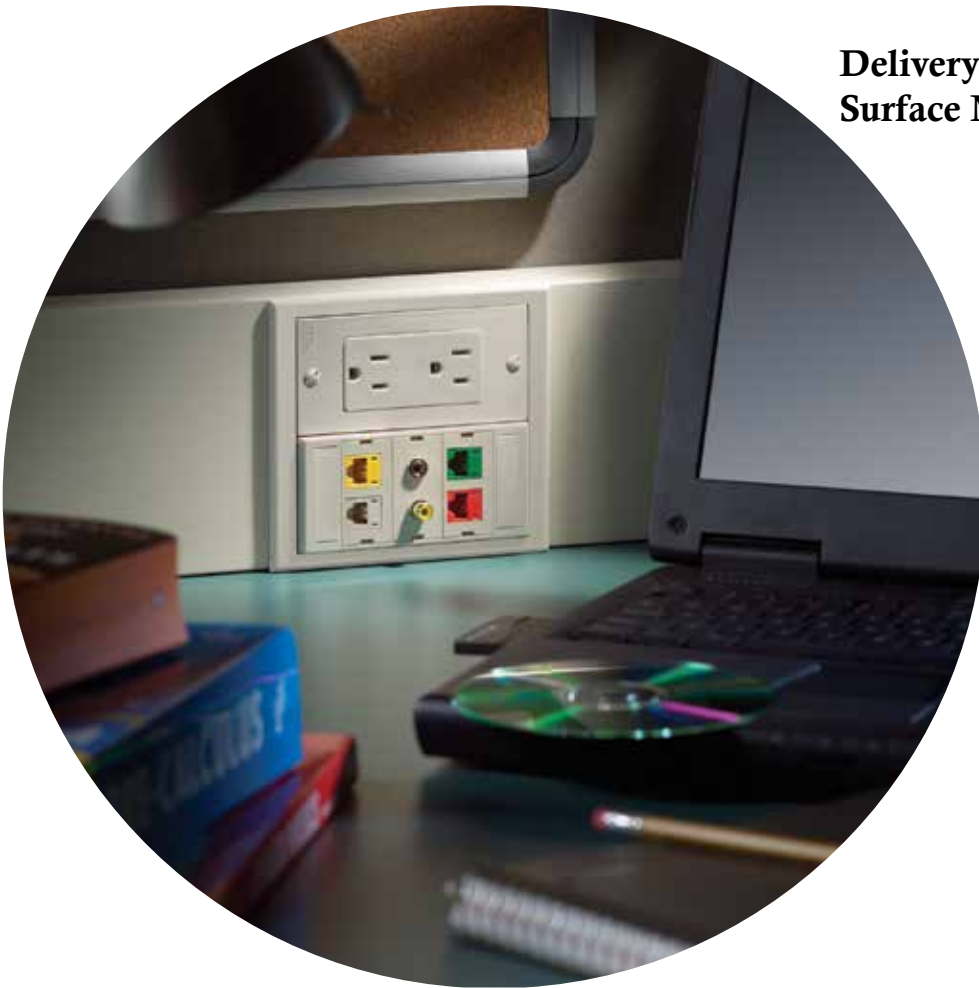

### RACEWAY

#### Non-Metallic Raceway

- Sizes range from single channel PREMISETRAK<sup>®</sup> to three channel Super BASETRAK<sup>®</sup> for all large capacity AV deployments
- Single and two channel latching raceways are dual-rated for power and data and AV applications
- Available with a variety of device boxes and bend radius control fittings

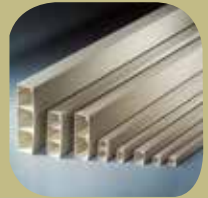

#### Aluminum Raceway

- External, internal, flat and tee fittings available to accommodate all types of AV applications
- Split covers allow access to each service at a time
- Low profile bezel cover accommodates Hubbell iSTATION modules



#### Metal Raceway

- Designed to accept AV, Category rated and fiber cabling
- Additional color options available for architects and interior designers
- Ideal for large multimedia applications in classrooms
- Available in single channel/single service or multiple channel/multiple service versions



# In the Rack

The NEXTFRAME® family of racks and cable management products are designed for today's AV and data cabling active gear requirements. NEXTFRAME products are designed to maximize air flow, support increased load capacity and provide easy access to cables and patch cords.



## AV Application: Loaded and Configurable Patch Panels

### CATEGORY RATED PATCH PANELS

- **Installation:** Industry's fastest terminating category rated patch panels
- **Application:** Verified for category rated performance; PoE and PoE+ ready



### UNLOADED KEYSTONE PATCH PANELS

- **Capacity:** 1U high-density 48-port panel maximizes rack space
- **Field configurable:** Ready for any combination of fiber, data and AV connections



### UNLOADED MODULE PATCH PANELS

- **Form Factor:** iSTATION format  
8 1U module spaces in 1RMU  
8 3U modules spaces in a 2RMU
- **Space savings:** Available in angled versions, eliminating the need for cable management

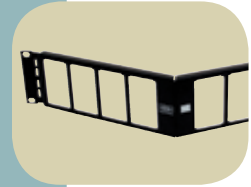

### UNLOADED Pro-AV PATCH PANELS

- **Configurable:** Pro audio design allows for customization of connections into a patch panel for easy access in racks and cabinets
- **Durability:** Rolled edge construction eliminates flex during termination

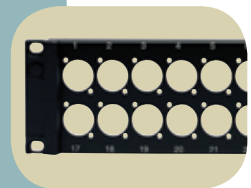

### PATCH PANELS

- High capacity patch panels are the ideal solution where rack space is at an absolute premium
- Customize UDX panels with mixed performance, multimedia, fiber and/or color where desired
- The UDX rear-loading keystone feature simplifies installation, MACs and provides migration path for future applications
- All panels comply with TIA-310-D rack mount standard



**TIP:** Hubbell's FCR fiber enclosures are an excellent way to consolidate AV fiber extenders and video distribution systems.



## Delivery Application: Equipment Racks



### RACKS

#### Wall Mounted Swing Racks

- Supports heavy or deep equipment in locations with limited floor space
- Quick release latches; rack frame hinges left and right
- Cable tie slots along both sides and inside top and bottom



#### Wall Mounted Racks

- Jumbo openings in sides and rear
- Side and bottom hinging for easy access to the rear of components
- Enhanced cable management — multiple tie-off points for both nylon and VELCRO<sup>®</sup> brand ties

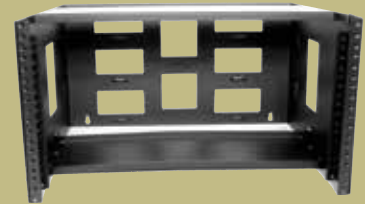

#### Free Standing Racks

- Available in 3" and 6" depths and various heights
- Rack mount unit is numbered for easy equipment location
- 6" deep rack supplies additional support for larger cable bundling and Category 6A applications



# In the Cabinet

Hubbell's innovative remote equipment cabinets meet the needs of any AV topology. Regardless of the environment and application, these enclosures provide aesthetics, functionality, security and flexibility. Accessories to support different applications include sound dampening, cooling, cable management, grounding and bonding and fiber provisions to effectively overcome distance limitations common with remote applications.



## RE-BOX® AND QUADCAB®

- Supports AV deployments in remote and space constrained areas
- Efficient integrated cabinet louvers are designed to dissipate 160W of heat; industry maximum without requiring a fan
- Large capacity openings designed for AV and category rated cable routing
- Cabinets are constructed in a broad range of sizes offering versatility for any AV application or design requirement



**TIP:** Ideal solution for side of staging, outdoor entertainment, sporting events and training centers.

## AV Application: Cabinet Accessories

### FAN KITS AND SOUND DAMPING

- **Air Flow:** Fan kits available for enhanced heat ventilation
- **Environmental:** Gasket kit protects against dust and water, enhancing performance of fan and filter



### GROUNDING

- **Safety:** Grounding strips are easily installed on inside rails and inside of cabinets
- **Installation:** Grounding kits are user configurable to accommodate different compression lug types and wire lengths

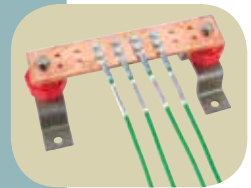

### MOUNTING ACCESSORIES

- **Configurability:**
  - 2 and 4 RMU flexible fold down patch panel brackets provide front access to rear for easy termination
  - 3 and 5 RMU active equipment rack mount brackets provide 19" mounting for active equipment to rear wall
- **Customization:** 3/4" plywood backboard provides universal mounting for brackets, splitters, extenders, USB hubs and other devices



### POWER STRIPS

- **Flexibility:** Standard 15A and 20A available with front and rear mounting options
- **Capacity:** Transformer spaced power strip provided with eight recessed 15A receptacles (4 on front and 4 on rear)



**Delivery Application:  
Remote Equipment Cabinets**



**CABINETS**

**Wall Mount Cabinet**

- Cabinet maintains structural integrity when fully loaded at 400lb
- Cabinet assembles in modular sections for easy installation
- Rear wall configured to easily mount AV splitters and extenders, keeping them clear of rack mounted gear



**IP Rated Cabinet**

- Deploy AV equipment in remote harsh environments
- Rated for NEMA 3R, 4X, 4, 12, and 13 environments
- Modular backboard system simplifies field configurations, optimizing cabinet space utilization



**Remote Wall Mount Cabinet**

- Perfect solution for small stage arrangements, classrooms or training/learning centers
- Accommodates large cable deployments with concentric knockouts for conduit and rectangular knockouts for metal and PVC raceway
- Door lifts off when open; hinge can be reversed in the field if required

## Hubbell Connectivity and Delivery Solutions

[www.hubbell-premise.com](http://www.hubbell-premise.com)



### Hubbell Premise Wiring Your complete online resource

Find what you need quickly with our multi-functional online value-added tools, print, zoom, search and download required information anytime, anywhere. Visit [www.hubbell-premise.com](http://www.hubbell-premise.com).

[www.hubbell-wiring.com](http://www.hubbell-wiring.com)



### Hubbell Wiring Device-Kellems

Your complete online resource

For complete wiring device offerings, visit [www.hubbell-wiring.com](http://www.hubbell-wiring.com).



### HUBBELL DATA CENTER BROCHURE

Data Center Solutions Guide assists data center professionals in identifying, specifying and deploying Hubbell Data Center Solutions to improve space utilization, reduce on-site labor, lower start-up costs and ensure a reliable network cabling infrastructure.



### RECESSED 6" AND 8" FIRE- RATED POKE-THROUGHS

Hubbell's SystemOne 6" and 8" Fire-Rated Poke-Throughs combine enhanced capacity with flexibility to accommodate changing user requirements for power, data and audio video connections.

These enhanced capacity FRPTs reduce the number of units required and the associated labor to serve user requirements.

### Literature Support

Hubbell offers an extensive literature library for product support. Downloadable PDFs are available online at [www.hubbell-premise.com](http://www.hubbell-premise.com) under the Resources tab.



**HUBBELL**<sup>®</sup>  
Wiring Systems

[www.hubbell-wiring.com](http://www.hubbell-wiring.com)  
[www.hubbell-premise.com](http://www.hubbell-premise.com)



Hubbell Wiring Device-Kellems  
Hubbell Incorporated (Delaware)  
40 Waterview Drive, Shelton, CT 06484  
Phone (800) 288-6000 • FAX (800) 255-1031

Hubbell Premise Wiring  
Hubbell Incorporated (Delaware)  
23 Clara Drive, Suite 103, Mystic, CT 06355  
Phone (800) 626-0005 • FAX (860) 535-8328

Printed in U.S.A. Specifications subject to change without notice. © Registered trademark of Hubbell Incorporated.

WSLBCD001R 07/14