



PUNQTUM
▶ BY RIEDEL

USER MANUAL

Q210 P – Speaker Station

Q-Series Network Based Intercom System

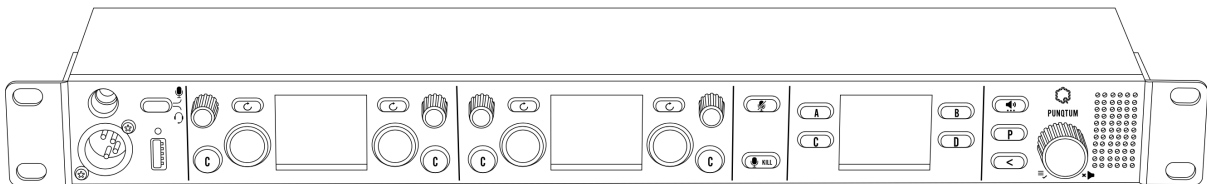

This manual is applicable for Firmware Version: 1.0

© 2022 Riedel Communications GmbH & Co. KG. All rights reserved. Under the copyright laws, this manual may not be copied, in whole or in part, without the written consent of Riedel. Every effort has been made to ensure that the information in this manual is accurate. Riedel is not responsible for printing or clerical errors. All trademarks are the property of their respective owners.

1	PREFACE	5
1.1	INFORMATION	6
2	ABOUT PUNQTUM Q-SERIES DIGITAL PARTYLINE INTERCOM SYSTEM	7
3	FRONT PANEL OPERATING ELEMENTS	8
4	BACK PANEL CONNECTORS	8
5	GETTING STARTED	9
5.1	POWERING UP	9
5.2	BACK PANEL CONNECTIONS	9
5.2.1	<i>Network Switch Connections</i>	10
5.2.2	<i>Connecting Program Signals and Public Address Outputs</i>	10
5.2.3	<i>Interface ports</i>	11
5.2.4	<i>General Purpose Inputs</i>	12
5.2.5	<i>General Purpose Outputs</i>	12
5.3	FRONT PANEL CONNECTIONS	13
5.3.1	<i>Gooseneck Microphone Connector</i>	13
5.3.2	<i>Headset Connector</i>	13
6	USING YOUR SPEAKER STATION	14
6.1	FRONT PANEL OPERATION ELEMENTS	14
6.1.1	<i>Headset Mic/Gooseneck Mic selector</i>	14
6.1.2	<i>Channel rotary encoder</i>	14
6.1.3	<i>Channel replay button</i>	14
6.1.4	<i>Channel CALL button</i>	14
6.1.5	<i>Channel TALK button</i>	14
6.1.6	<i>Mic Mute button</i>	14
6.1.7	<i>Mic KILL button</i>	15
6.1.8	<i>A/B/C/D Buttons</i>	15
6.1.9	<i>Volume Button</i>	15
6.1.10	<i>Alternate Page button</i>	16
6.1.11	<i>Main Rotary Encoder</i>	16
6.1.12	<i>Back Button</i>	16
6.2	CHANNEL DISPLAYS	17
6.2.1	<i>Channel Volume (A)</i>	17
6.2.2	<i>Channel Name (B)</i>	17
6.2.3	<i>TALK active indication (C)</i>	17
6.2.4	<i>CALL active indication (D)</i>	17
6.2.5	<i>TALK button operation modes (E)</i>	18
6.2.6	<i>ISO active indication (F)</i>	18
6.2.7	<i>IFB active indication (G)</i>	18
6.2.8	<i>Audio receive indication (H)</i>	18
6.2.9	<i>Channel User Count (I)</i>	18
6.2.10	<i>Replay available indication (K)</i>	19
6.3	A/B/C/D BUTTON DISPLAY	20
6.3.1	<i>Public Announce, Talk to All and Talk to Many</i>	20
6.3.2	<i>Control switching</i>	20
6.3.3	<i>System Mute function</i>	21
6.3.4	<i>System Silent function</i>	21
6.3.5	<i>Partyline system device count</i>	21
6.3.6	<i>PGM indication</i>	21
6.3.7	<i>Button operation modes</i>	21
7	MENU OPERATION	22

7.1	LOCK DEVICE	23
7.2	CHANGE ROLE.....	23
7.3	CHANGE I/O SETTINGS	24
7.4	DISPLAY	24
7.4.1	<i>Brightness</i>	24
7.4.2	<i>Dark screen saver</i>	24
7.5	MICROPHONE SETTINGS	25
7.5.1	<i>Microphone gain</i>	25
7.5.2	<i>Microphone type</i>	25
7.5.3	<i>Band pass filter</i>	25
7.5.4	<i>Vox threshold</i>	26
7.5.5	<i>Vox release</i>	26
7.6	ANALOG I/O SETTINGS	26
7.6.1	<i>Analog Input</i>	26
7.6.2	<i>Analog output</i>	26
7.6.3	<i>External Speaker Output</i>	27
7.7	INTERFACE SETTINGS	27
7.7.1	<i>Interface Input Gain</i>	27
7.7.2	<i>Interface Output Level</i>	27
7.8	PROGRAM INPUT	27
7.9	DEVICE	28
7.9.1	<i>Reset local changes</i>	28
7.9.2	<i>Save personal settings</i>	28
7.9.3	<i>Load personal settings</i>	28
7.9.4	<i>Factory reset</i>	28
7.10	ABOUT.....	29
7.10.1	<i>Device name</i>	29
7.10.2	<i>IP address</i>	29
7.10.3	<i>Firmware version</i>	29
7.10.4	<i>Hardware version</i>	29
7.10.5	<i>MAC address</i>	29
8	Q-TOOL	30
9	TECHNICAL SPECIFICATIONS	30

1 Preface

Welcome to the punQtum digital intercom family!

This document provides detailed information about the punQtum Q-Series digital partyline system, pin outs, mechanical and electrical data.

NOTICE

This manual, as well as the software and any examples contained herein are provided “as is” and are subject to change without notice. The content of this manual is for informational purposes only and should not be construed as a commitment by Riedel Communications GmbH & Co. KG. or its suppliers. Riedel Communications GmbH & Co. KG. gives no warranty of any kind with regard to this manual or the software, including, but not limited to, the implied warranties of marketability or fitness for a particular purpose. Riedel Communications GmbH & Co. KG. shall not be liable for any errors, inaccuracies or for incidental or consequential damages in connection with the furnishing, performance or use of this manual, the software or the examples herein. Riedel Communications GmbH & Co. KG. reserves all patent, proprietary design, title and intellectual property rights contained herein, including, but not limited to, any images, text, photographs incorporated in the manual or software.

All title and intellectual property rights in and to the content that is accessed through use of the products is the property of the respective owner and is protected by applicable copyright or other intellectual property laws and treaties.

1.1 Information

Symbols

The following tables are used to indicate hazards and provide cautionary information in relation to the handling and use of the equipment.

	This text indicates a situation that needs your close attention. It may also be used to alert against unsafe practice.
---	--

	This text is for general information. It indicates the activity for ease of work or for better understanding.
---	---

Service

- All service must be provided ONLY by qualified service personnel.
- There are no user-serviceable parts inside the devices.
- Do not plug in, turn on or attempt to operate an obviously damaged device.
- Never attempt to modify the equipment components for any reason.

	All adjustments have been done at the factory before the shipment of the devices. No maintenance is required and no user-serviceable parts are inside the unit.
---	---

Environment

- Never expose the device to high concentrations of dust or humidity.
- Never expose the device to any liquids.
- If the device has been exposed to a cold environment and transferred to a warm environment, condensation may form inside the housing. Wait at least 2 hours before applying any power to the device.

Disposal

	This symbol, found on your product or on its packaging, indicates that this product should not be treated as household waste when you wish to dispose of it. Instead, it should be handed over to an authorized collection point for the recycling of electrical and electronic equipment. By ensuring this product is disposed of correctly, you will help prevent potential negative consequences to the environment and human health, which could otherwise be caused by inappropriate disposal of this product. The recycling of materials will help to conserve natural resources. For more detailed information about the recycling of this product please contact the local authority responsible.
---	---

2 About punQtum Q-Series Digital Partyline Intercom System

punQtum Q-Series digital partyline intercom system is a digital, easy to use, full-duplex communications solution for theater and broadcast applications as well as for all kinds of cultural events like concerts, etc.

It is an all-new, network-based partyline intercom system which combines all standard partyline system features and more with the advantages of modern IP networks. punQtum Q-Series works on standard network infrastructure and is easy to install and set up. The system works “out of the box” with a factory default configuration but can be quickly configured by user-friendly software to meet individual needs.

The system is completely decentralized. There is no master station or any other central point of intelligence in the whole system. All processing is handled locally in each device. The capacity of one partyline intercom system is set to a maximum of 32 channels, 4 program inputs, up to 4 public announce outputs and 32 control outputs.

punQtum Q-Series digital partyline system is based on Roles and I/O settings to ease the use and administration of partyline intercom systems.

A Role is a template for the channel configuration of a device. This allows channel settings and alternate functions to be predefined for different Roles needed to run a live show. As an example, think of the stage manager, sound, light, wardrobe and security personnel having different communication channels available to deliver a perfect job.

An I/O setting is a template for the settings of the equipment connected to a device. This, for example, allows I/O settings to be available for different Headsets being used at a venue to cover for different environmental situations.

Each device can be configured to any Role and I/O setting available.

Multiple punQtum partyline intercom systems can share the same network infrastructure. This allows for the creation of production islands within a campus using the same IT network infrastructure. The number of devices (Beltpacks/Speaker Stations) is theoretically infinite but limited by the network capacity. Beltpacks are powered by PoE, either from a PoE switch or from a Speaker Station. They can be daisy-chained to reduce wiring efforts on site.

Beltpacks support simultaneous use of 2 channels with separate TALK and CALL buttons as well as one rotary encoder for each channel. An alternate page button allows the user to quickly reach alternate functions such as public announce, Talk To All, Talk To Many, to control general purpose outputs and access system functions like Mic Kill asf. The Beltpack is designed with a combination of premium materials, including high-impact plastics and rubber to make it both tough and comfortable to use in any situation.

punQtum Q-Series Beltpacks and Speaker Stations allow users to replay missed or not understood messages. Program input signals can be fed into the system using an analog audio input at any Speaker Station.

Sunlight readable, dimmable RGB color displays used for Beltpacks and Speaker Stations make for excellent readability of the intuitive user interface.

3 Front Panel Operating Elements

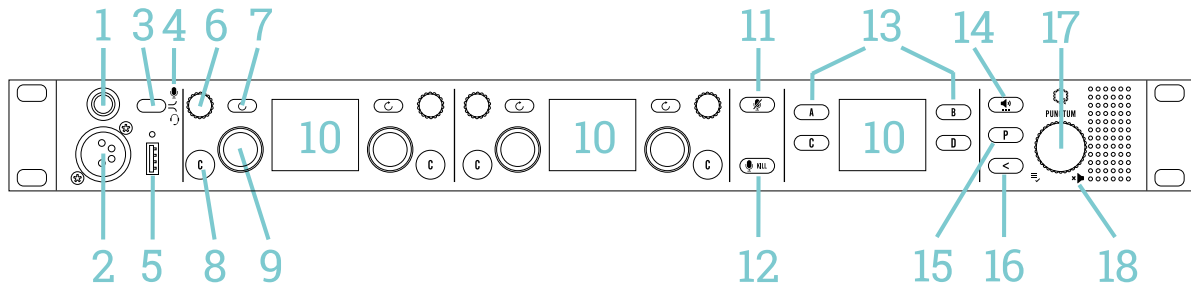

- | | |
|-------------------------------|---------------------------|
| 1. Gooseneck mic connector | 10. Color TFT display |
| 2. Headset connector | 11. Mic Mute button |
| 3. Headset/Gooseneck selector | 12. Mic KILL button |
| 4. Headset/Gooseneck LED | 13. A/B/C/D buttons |
| 5. USB host connector | 14. VOLUME button |
| 6. Rotary encoder | 15. Alternate page button |
| 7. REPLAY button | 16. BACK button |
| 8. CALL button | 17. Main Rotary encoder |
| 9. TALK button | 18. Speaker-Muted LED |
- } per channel

4 Back Panel Connectors

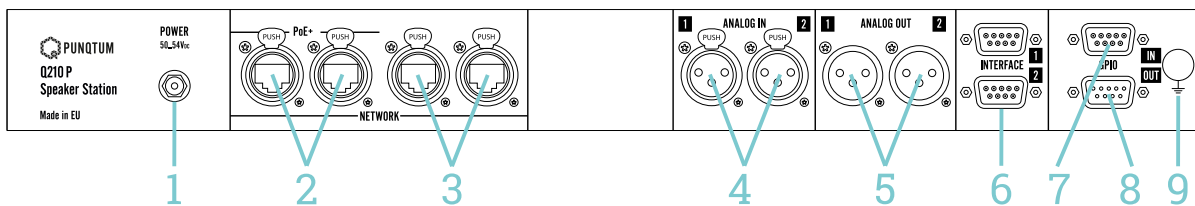

- | | | |
|------------------------|----------------------------|---------------------------|
| 1. DC power connector | 4. Balanced analog inputs | 7. GPI inputs |
| 2. Network with PoE+ | 5. Balanced analog outputs | 8. GPI outputs |
| 3. Network without PoE | 6. Interface ports | 9. Protective earth screw |

5 Getting Started

The Q210 P Speaker Station is your intercom network center. It is delivered with a factory default system configuration and will work “out of the box” together with Q110 Beltpacks in factory default system configuration.

The Speaker Station supports the use of a monaural headset or a gooseneck microphone used together with the built in or an externally connected speaker. The Speaker Station supports the use of both dynamic and electret microphones.

5.1 Powering Up

Only use the provided AC/DC power adapter for powering the Q210 P Speaker Station.

5.2 Back Panel Connections

The Q210 P Speaker Station provides 4 network switch connectors, 2 analog inputs, 2 analog outputs, 4 general purpose inputs, 4 general purpose outputs and 2 universal interface connections to complete your system. The factory default system configuration supports plug and play use of the network switch connectors and all analog inputs and outputs.

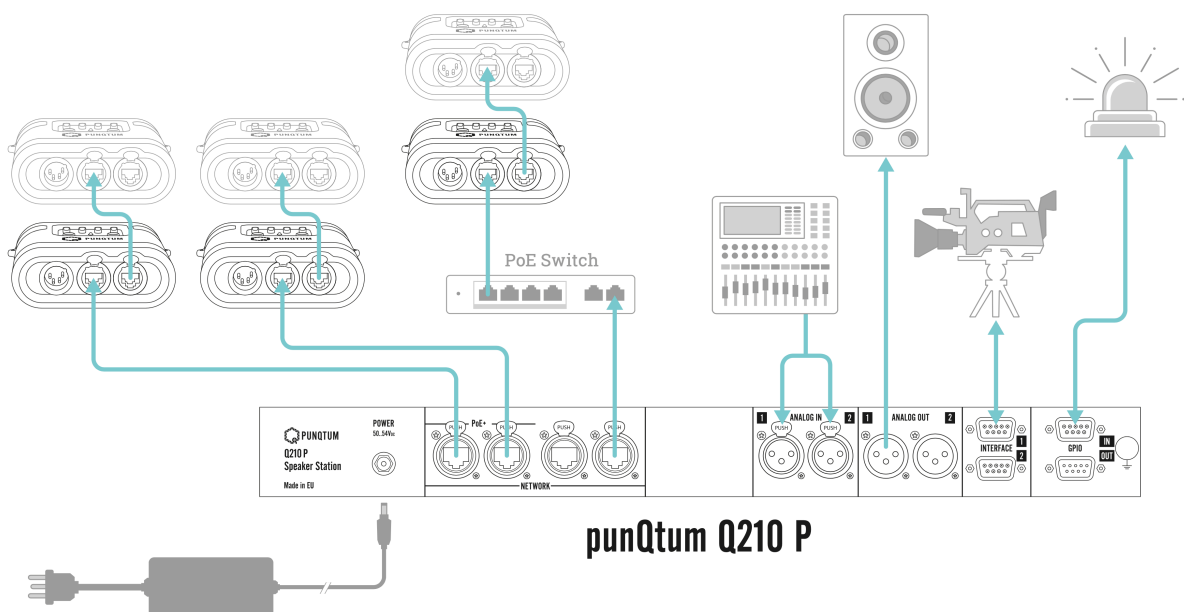

5.2.1 Network Switch Connections

The Q210 P Speaker Station provides 4 network switch ports to connect Q110 Beltpacks and other equipment.

The network ports labeled PoE+ can power up to 4 daisy chained Q110 Beltpacks each. No additional network equipment is needed to run punQtum Q-Series digital partyline intercom systems. However, punQtum Q-Series digital partyline intercom systems can easily be integrated into existing network infrastructure.

5.2.1.1 Multicast Audio Streams

If you do not have any other audio streams present in your network infrastructure, you will most probably be fine.

If you are using punQtum Q-Series digital partyline intercom systems in networks together with other audio network streaming technologies such as Ravenna, DANTE™ or other multicast-based streaming technologies, you need to make sure that your network infrastructure is capable of supporting IGMP (Internet Group Management Protocol) and that IGMP is correctly set up and configured:

	<p>If you use a single switch only, it is irrelevant if the switch has IGMP snooping (aka multicast filtering) enabled or not. As soon as you have two switches, and one or more switches happen to have IGMP snooping enabled, it is necessary to configure one and only one IGMP querier in the network (usually, you select one switch). Without an IGMP querier, the multicast traffic will stop after a while due to IGMP timeouts. punQtum Q-Series digital partyline system supports IGMP V2.</p>
---	--

5.2.2 Connecting Program Signals and Public Address Outputs

2 independent program signals can be connected to the balanced analog inputs. On each device of your system, you can select which program input shall be heard.

Analog Input Connector: Type XLR 3pin, female

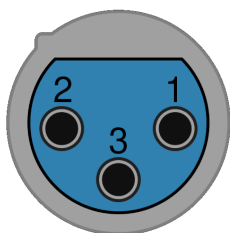

Pin	Name	Description
1	GND	Audio ground and shield
2	A+	Audio (positive)
3	A-	Audio (negative)

Please refer to the datasheet for technical details.

2 independent public address signals are available as balanced analogue outputs. Connect your lobby speakers and your wardrobe speakers to these outputs for example.

Analog Output Connector: Type XLR 3pin, male



Pin	Name	Description
1	GND	Audio ground and shield
2	A+	Audio (positive)
3	A-	Audio (negative)

Please refer to the datasheet for technical details.

5.2.3 Interface ports

The Q210 P Speaker Station provides 2 interface ports to be used with cameras and other external equipment. Interface ports carry Channel and Program audio signals and are freely configurable in Q-Tool. Please consult Q-Tool help for more details. Interface ports are not part of the factory default configuration system.

Q210 P Interface Port

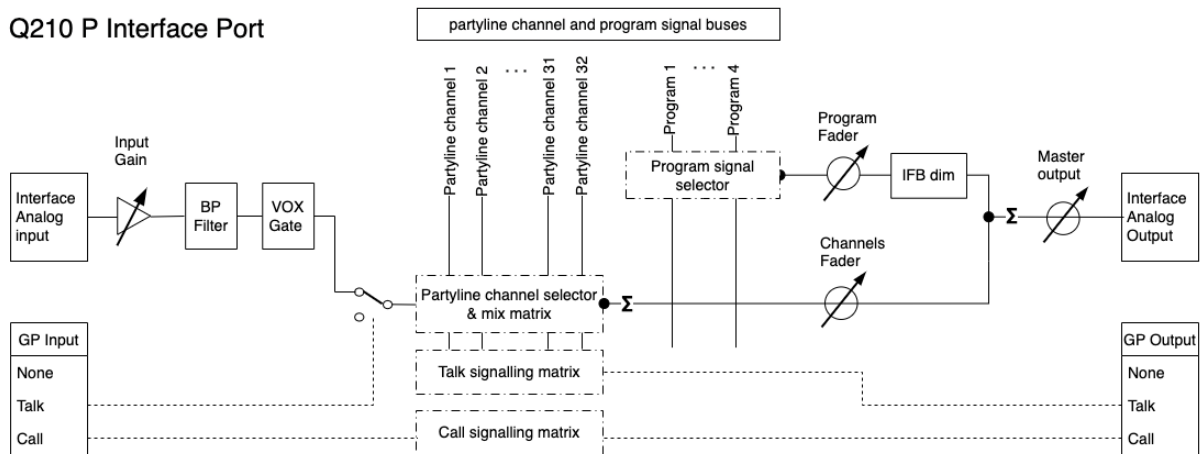

Pin	Name	Description
1	Audio Out +	Balanced audio output (positive)
2	GP Out A	General-purpose output (positive)
3	GND	Audio ground
4	GP In B	General-purpose input (negative)
5	Audio In -	Balanced audio input (negative)
6	Audio Out -	Balanced audio output (negative)
7	GP Out B	General-purpose output (negative)
8	GP In A	General-purpose input (positive)
9	Audio In +	Balanced audio input (positive)

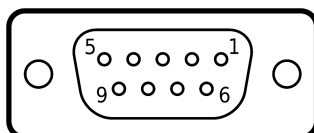

Connector type:
D-Sub 9pin, female

The electrical specification for the GP Inputs and Outputs present on the universal connectors are the same as for the General Purpose Interfaces. Please refer to the datasheet for details.

5.2.4 General Purpose Inputs

General purpose inputs (GPI) can be used to control system functions or act the same as buttons available on the Q210 P Speaker Station front panel. They can also be assigned to any of control channels available per punQtum Q-Series digital partyline system.

GPI are freely configurable in Q-Tool. They are not used as part of the factory default configuration system.

GPI are galvanically isolated current sensing inputs. Please refer to the datasheet for details.

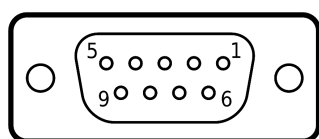

Connector type:
D-Sub 9pin, female

Pin	Name	Description
1	GP In-1 +	General-purpose input #1 (positive)
2	GP In-2 +	General-purpose input #2 (positive)
3	GP In-3 +	General-purpose input #3 (positive)
4	GP In-4 +	General-purpose input #4 (positive)
5	GND	Power ground
6	GP In-1 -	General-purpose input #1 (negative)
7	GP In-2 -	General-purpose input #2 (negative)
8	GP In-3 -	General-purpose input #3 (negative)
9	GP In-4 -	General-purpose input #4 (negative)

5.2.5 General Purpose Outputs

General purpose outputs (GPO) can be used to make system, call or talk states of partylines available externally. They can also represent the state of one of the 32 freely assignable control channels available per punQtum Q-Series digital partyline system.

GPO are freely configurable in Q-Tool. They are not used as part of the factory default configuration system.

GPI are galvanically isolated switching outputs. Please refer to the datasheet for technical details.

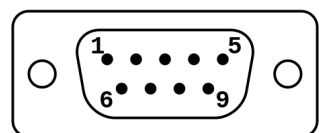

Connector type:
D-Sub 9pin, male

Pin	Name	Description
1	GP Out-4 A	General-purpose output #4 (A)
2	GP Out-3 A	General-purpose output #3 (A)
3	GP Out-2 A	General-purpose output #2 (A)
4	GP Out-1 A	General-purpose output #1 (A)
5	+5V	5V power (max. 150mA)
6	GP Out-4 B	General-purpose output #4 (B)
7	GP Out-3 B	General-purpose output #3 (B)
8	GP Out-2 B	General-purpose output #2 (B)
9	GP Out-1 B	General-purpose output #1 (B)

5.3 Front Panel Connections

5.3.1 Gooseneck Microphone Connector

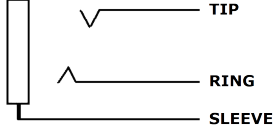

Pin	Description
Tip	Microphone + / +5V bias voltage for electret mic
Ring	Microphone -
Sleeve	Microphone - / GND

The gooseneck microphone connector is a 1/4"/6.3 mm Jack TRS connector with 7/16" -20 UNF thread. It supports electret or dynamic microphones.



The microphone bias power (+5.8V) will be switched on/off according to the mic type setting. This can be changed directly in the Speaker Station menu 7.5.2

5.3.2 Headset Connector

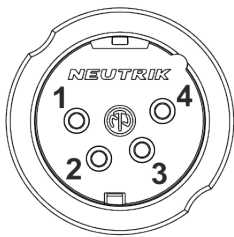

Pin	Description
1	Microphone -
2	Microphone + / +5V bias voltage for electret mic
3	Earphones -
4	Earphones +

The headset connector is a 4-pole male XLR connector and supports monoaural headsets with electret or dynamic microphones.



The microphone bias power (+5.8V) will be switched on/off according to the mic type setting. This can be changed directly in the Speaker Station menu 7.5.2

6 Using your Speaker Station

A Speaker Station that is “new out of the box” includes a factory default system configuration. This allows all devices in factory default configuration to communicate without the need of the Q-tool configuration software.

6.1 Front Panel operation elements



6.1.1 Headset Mic/Gooseneck Mic selector

Change between using a connected headset or a connected gooseneck microphone plus the built-in speaker for communication. The selected mode is indicated using LED's. If Headset is selected, a speaker mute indicator *▶ is lit in addition.

Using Q-tool, you have the option to direct the speaker signal to one of the analog outputs instead of to the speaker.

Volumes of headset and speaker output can be set individually.

6.1.2 Channel rotary encoder



Moving the rotary knob clockwise will increase the volume, counterclockwise operation will decrease the volume.

Pushing the rotary encoder will mute / unmute the Channel.

6.1.3 Channel replay button



Use this button to start the replay of the last recorded message of a channel. See Replay available indication (K) for additional information on the replay function.

6.1.4 Channel CALL button



Use this button to issue a CALL signal on the Channel. If the CALL signal remains active for more than two seconds by pushing a call button for more than 2 seconds an ALARM signal will be issued on the channel. See 6.2.4 for additional information on the CALL function.

6.1.5 Channel TALK button



Use this button to talk to the Channel. A talk button offers different operation modes explained here: 6.2.5

6.1.6 Mic Mute button



Use this button to quickly mute the microphones connected to your Speaker Station. This is a handy feature to avoid any unwanted communication to any otherwise active channel when you have to discuss something with a person coming to your desk.

Active mic mute is shown on your Speaker Station like this:

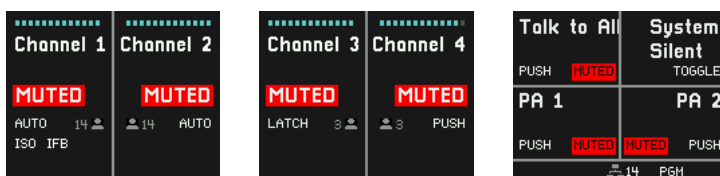

6.1.7 Mic KILL button



Clicking the Mic Kill button on a device will reset all active TALK functions of the channels the device Role is assigned to. A long press on the Mic Kill button will reset all active TALK functions of all channels available in the system configuration. The purpose of this function is to be able to 'silence' overly busy channels to be able to transmit important / urgent messages.

6.1.8 A/B/C/D Buttons



Pressing the A/B/C/D buttons gives you direct access to functions like Public Announce, Talk To All and Talk To Many, Control switching, System Mute, System Silent and Mic Kill. You can assign any of above functions to a Button of your choice using Q-tool configuration software.

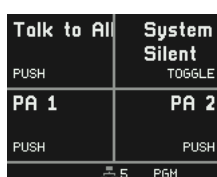

6.1.9 Volume Button



Pressing the Volume Button will cycle you through all available volume settings depending on your headset/speaker selection:



Figure 1 Volume settings

You may adjust each volume setting using the main rotary encoder. Your settings are stored in your Speaker Station.

Headset volume sets the overall volume for your headset.

Speaker volume sets the overall volume for your built-in speaker or external Speaker connected.

Program volume controls the volume of your program input.

Buzzer volume controls the volume of the CALL and ALARM signals.

Sidetone volume controls the volume of your own voice.

6.1.10 Alternate Page button



Pressing the Alternate Page button  will temporarily give access to an additional set of four functions like public announce, Talk To All and Talk To Many, controls switching, System Mute, System Silent and Mic Kill. You can assign a maximum of 4 functions to button A/B/C/D of the alternate page using Q-tool configuration software.

A yellow bottom bar indicates an active alternate page.

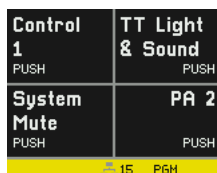

A second press on the Alternate Page button or a press on the Back button will leave the alternate page.

If no functions are assigned to the alternate page, the Alternate Page button is inactive.

6.1.11 Main Rotary Encoder



Use the main rotary encoder to adjust the output volume of your Speaker Station.

Pushing the main rotary encoder gives access to the setup menu. See Chapter Menu operation.

A long press on the main rotary encoder briefly shows the device name and installed FW version.



6.1.12 Back Button



Use the Back button to navigate backwards in the menu or to leave the alternate page.

6.2 Channel Displays

The left and middle Speaker Station displays show information on status and configuration of the channels activated for the current role.

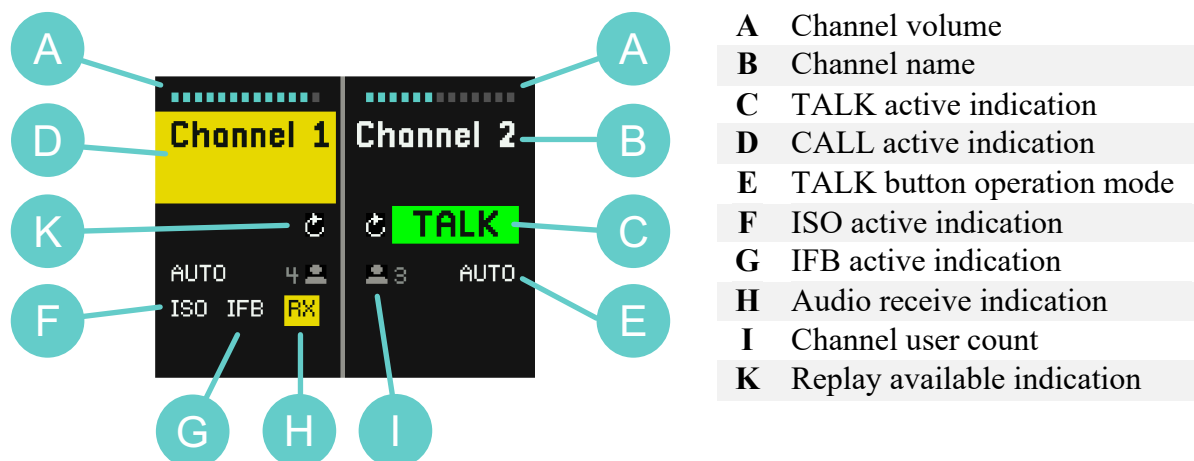

6.2.1 Channel Volume (A)



Channel volume control can be set by the rotary encoder knobs (6 on Front Panel Operating Elements) next to the replay button of each channel of the Speaker Station. Moving the rotary knob clockwise will increase the volume, counterclockwise operation will decrease the volume. Pushing the rotary encoder will mute / unmute the Channel.

6.2.2 Channel Name (B)



The Channel Name shown is the Name as defined in the system configuration using Q-Tool.

6.2.3 TALK active indication (C)



An active TALK function is indicated in the display per Channel. Use the TALK buttons (9 on Front Panel Operating Elements) to switch on and off the TALK status of each Channel.

6.2.4 CALL active indication (D)



If a CALL signal is received on a Channel, the display will show a yellow flashing square on the Name of the Channel. A CALL buzzer signal will be heard at the same time.

If a Call button is pushed for more than 2 seconds the display will flash with a larger section of the Channel. At the same time, a different buzzer signal will be heard to indicate the ALARM type call.

The volume of the buzzer signal can be changed individually on each device, see Volume Button.

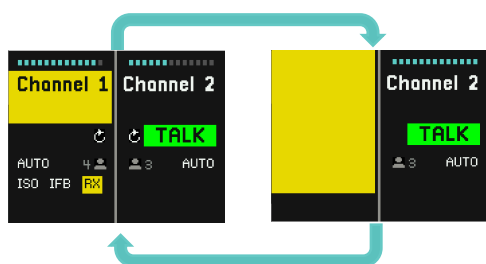

6.2.5 TALK button operation modes (E)



The TALK button offers three operation modes.

1. AUTO, a double function:
 - Push the TALK button momentarily, the TALK function is now latched on.
 - Push the TALK button momentarily, the TALK function is now off.
 - Push and hold the TALK button, the TALK function is active as long as the TALK button is held. When the TALK button is released the TALK function is switched off.
2. LATCH:
 - Push the TALK button momentarily, the TALK function is now latched on.
 - Push the TALK button momentarily, the TALK function is now off.
3. PUSH:
 - Push and hold the TALK button, the TALK function is active if the TALK button is held. When the TALK button is released, the TALK function is switched off.

TALK button operation mode can be set using Q-Tool configuration software.

6.2.6 ISO active indication (F)



The symbol ISO indicates an active Isolate function. When you activate the TALK button of a Channel with activated ISO function, you will only hear the users of that Channel. Audio from other Channels is muted to improve intelligibility of this particular channel you are talking to. The Program input is not muted.

6.2.7 IFB active indication (G)



The symbol IFB indicates an active interruptible foldback. The program input signal level is dimmed by the amount specified in a Role if someone is speaking on the Channel.

6.2.8 Audio receive indication (H)



The yellow RX indication is shown if audio is being received on the Channel.

6.2.9 Channel User Count (I)



Shows the number of users available on this channel. If the symbol is shown in red and indicating 1 user, you are the only user of this channel.

6.2.10 Replay available indication (K)



Replay indication will be shown if there is a recording present on that Channel.

Recorded messages can be replayed by pushing the replay button of the Channel. The last recorded message will be played back immediately

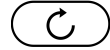

The Channel display will show the replay status.

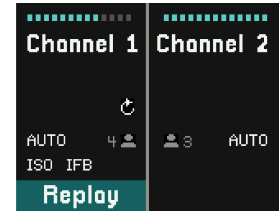

The Speaker Station's right display informs about how long ago each message was recorded and how long each recorded message is. Start playback of each individual message by pressing buttons A to C. The bottom line tells you which Channel the message was recorded from and indicates the volume setting. While playing back you may use the Channel volume encoder or the main rotary encoder to adjust the Channel volume.

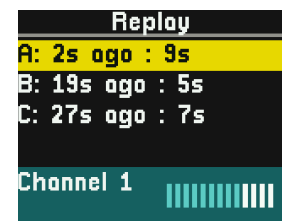

Pressing the Back button ends playback of recorded messages and returns to normal operation mode.

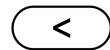

A long press on the Back button deletes all recorded messages.

6.3 A/B/C/D button display

Public Announce, Talk to Many, Control and System functions can be assigned to buttons A to D and are shown in the right Speaker Station display.

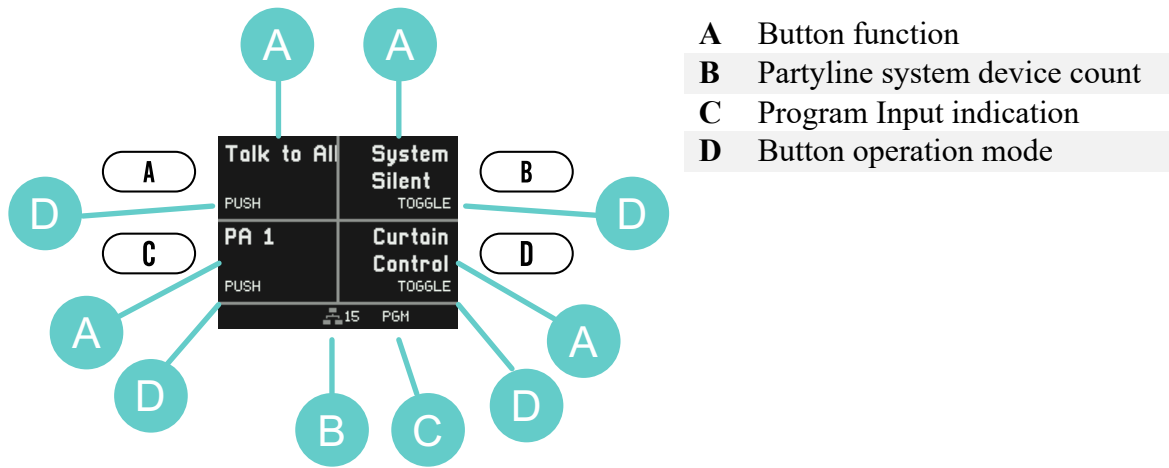

6.3.1 Public Announce, Talk to All and Talk to Many

A

The function can be activated by pressing the button near the quadrant. The display will show a green TALK indication, or a red BUSY indication if someone else is already using this function. Once the other user disables his TALK function, your TALK will show green and you can start talking.

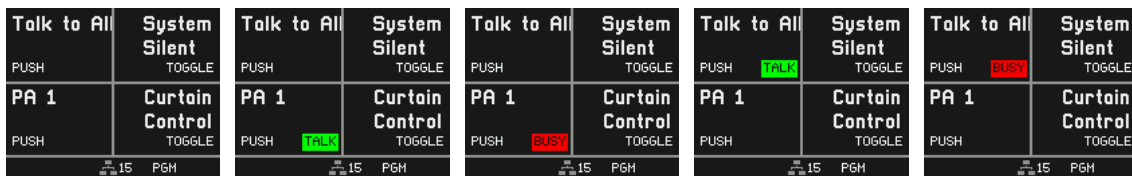

6.3.2 Control switching

A

Control states can be changed from any device of a punQtum Q-Series digital partyline intercom system. If a Control has an active state, you will see a yellow ACT indicator. The state of control is made available to external devices through the General Purpose Outputs on the rear side.

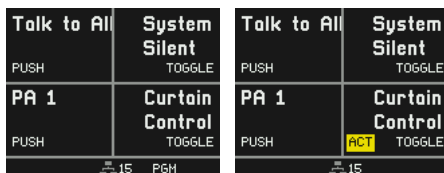

6.3.3 System Mute function

A

System Mute disables all CALL and TALK functions and mutes all program input signals. It stays active as long as the button is pressed (PUSH behavior). An active System Mute is shown with an orange MUTED indicator.

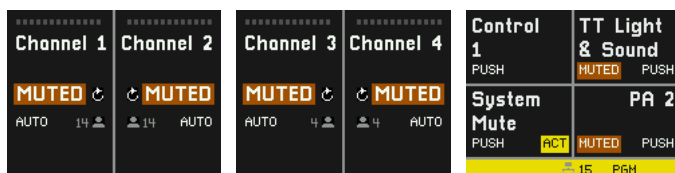

6.3.4 System Silent function

A

System Silent mutes the Q210P Speaker Station speaker and prevents any other punQtum devices from making sound. Public announcements remain functional, optical signaling when using a CALL function remains functional as well. The function is activated through a button push. Pressing the button again deactivates the function (TOGGLE behavior). An active System Silent is shown with an orange SILENT indicator.

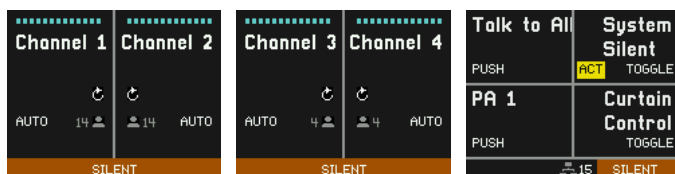

6.3.5 Partyline system device count



Shows the number of all units participating in your partyline intercom system. If the symbol is shown in red and indicating 1, your device is the only one in the system.

6.3.6 PGM indication



The PGM symbol indicates a selected Program input. If the symbol is shown in white the Program input is received, if red, the selected Program input is not received.

Program inputs are only available if configured on a punQtum Q210P Speaker Station as part of the partyline system.

6.3.7 Button operation modes



Buttons assigned to Controls can have TOGGLE or PUSH behavior:

- TOGGLE: Any short press on any assigned button changes the state of the Control. If a Control has an active state, it will be shown with a yellow ACT indicator.
- PUSH: Pressing and holding an assigned button will activate the function until the button is released again.

Please see 6.2.5 for TALK button operation modes.

7 Menu operation

Role and I/O setting define most of the settings for the user. Some of the items can be changed by the user via the Menu. If menu items are locked in Q-Tool for the active role, they are not displayed in the menu.

-  Push the main rotary encoder to enter the Menu, turn it to navigate through the Menu, and push it to select an item.
-  Use this button to step backwards or exit the Menu.

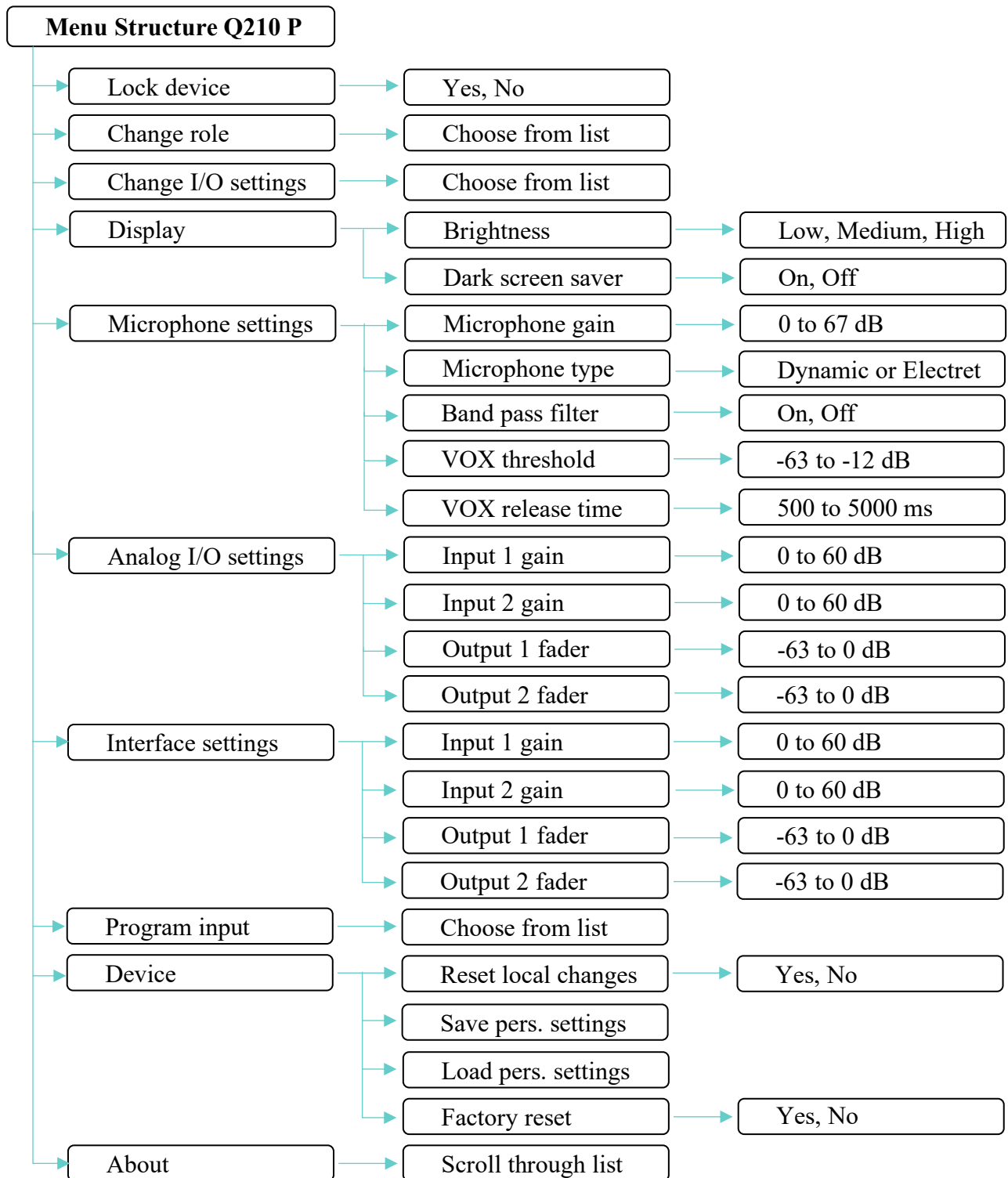

7.1 Lock device

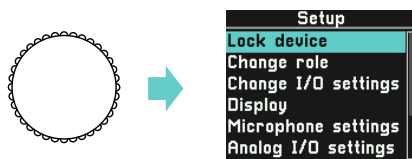

Role settings for your device may include an option to lock the front panel using a 4 digit pin. The pin is defined per Role in Q-Tool configuration software.

The Lock device menu entry is only shown if the selected Role has an active lock front panel option.

Note that the factory default configuration does not include front panel locking.

To lock your device, select 'Lock device' and push the main rotary encoder to confirm. The microphone of your device will be muted and the lock screen is showing the name of the selected role:

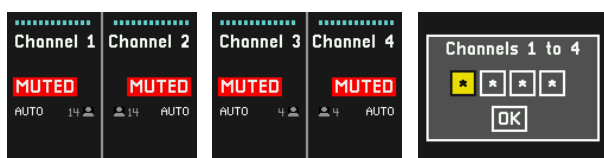

To unlock your device, enter the 4-digit pin using the main rotary encoder and confirm the unlock. The Back button allows scrolling back through the digits.



The backpanel connections of a Speaker Station continue working regardless of the lock state of the device except for an analog output configured to 'Ext Speaker'.

7.2 Change Role

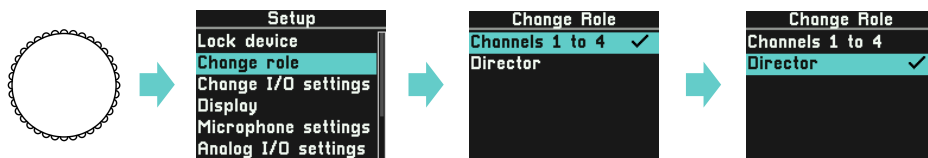

You may change your active Role. Roles can be defined with the help of Q-Tool configuration software.

7.3 Change I/O settings

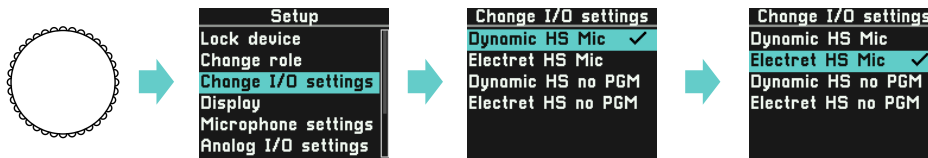

Select from different I/O settings presets. Q-Tool configuration software allows to define more I/O settings to match the specifics of external devices connected to your Speaker Station.

7.4 Display

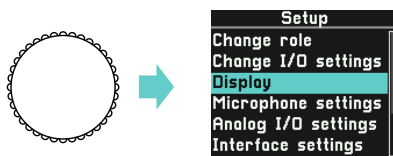

7.4.1 Brightness

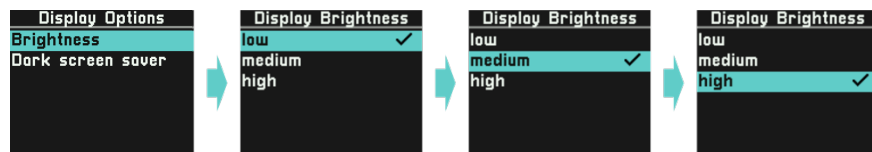

The display backlight can be varied in three steps and is stored on your device.

7.4.2 Dark screen saver

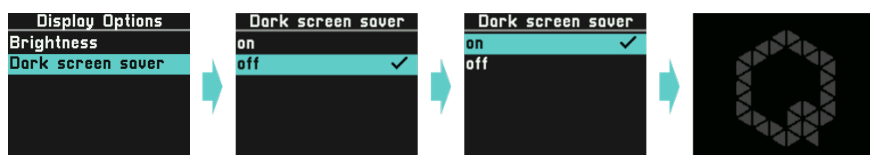

If the Dark screen saver is enabled, it will be activated automatically and deactivated by any button press or encoder turn. It will show a very low-brightness Q logo when active.

7.5 Microphone settings

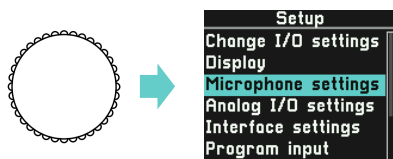

Microphone settings enable access to the settings predefined in the I/O settings and enables fine-tuning the settings according to your specific situation. Your settings will be stored on the device and are applied again when you power up your device.

7.5.1 Microphone gain

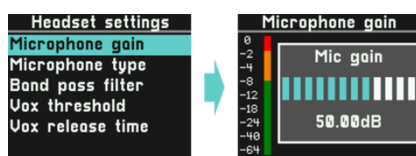

The microphone gain can be adjusted from 0 dB to 67 dB. A VU meter provides valuable feedback while adjusting the gain. Speak into your microphone and adjust the level to be in the upper green and orange range. Try to avoid the red level to minimize distortion and avoid clipping.

7.5.2 Microphone type

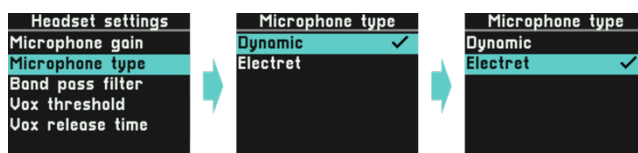

Electret microphones require a bias voltage for correct operation. If you set the microphone type to electret, a bias voltage will be applied to the microphone input. Dynamic microphones can work without bias voltage.

7.5.3 Band pass filter

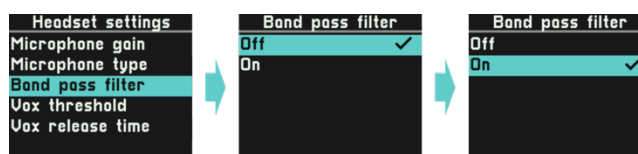

The Band pass filter removes lower and higher frequencies from your microphone signal to improve speech intelligibility. Activate it if needed.

7.5.4 Vox threshold

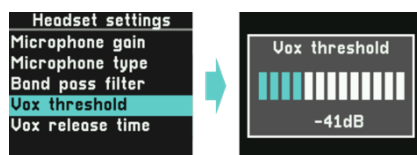

The Vox threshold level determines at which level an audio signal is passed on to the system. The Vox function is used to reduce background noise in the system.



Make sure your speech level is higher than the VOX threshold level. The range can be varied from -64dB to -12dB.

7.5.5 Vox release

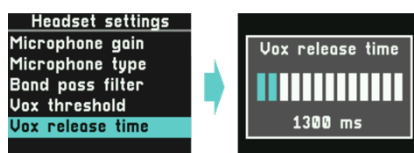

The Vox release time determines how long your speech signal will be passed on to the system once the signal level drops below the VOX threshold level. This is used to avoid chopping your speech. The VOX release time can be set from 500 milliseconds to 5 seconds in steps of 100 milliseconds.

7.6 Analog I/O settings

7.6.1 Analog Input

Adjust the gain of the backpanel analog inputs according to your needs. This overrides the settings that came with the I/O settings you chose for your Speaker Station.

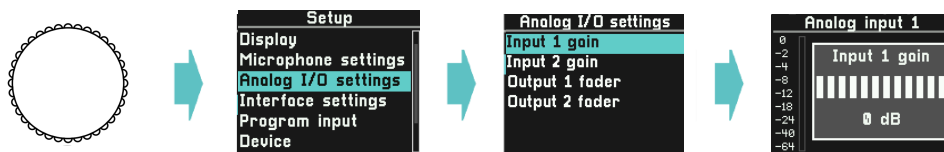

7.6.2 Analog output

Adjust the fader of the backpanel analog outputs according to your needs. This overrides the settings that came with the I/O settings you chose for your Speaker Station.

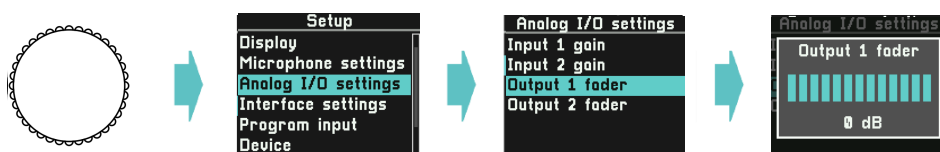

7.6.3 External Speaker Output

If one of your analog outputs is configured to ‘External Speaker Output’ you can adjust the maximum output level sent to your external speaker input, so it does not produce a distorted signal. Speaker volume is adjusted like described in 6.1.9 Volume Button.  This overrides the setting that came with the I/O settings you chose for your Speaker Station.

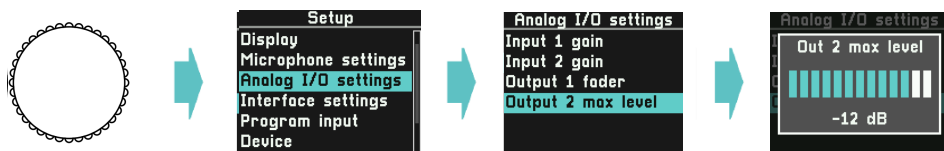

7.7 Interface settings

7.7.1 Interface Input Gain

Adjust the gain of the backpanel interface inputs according to your needs. This overrides the settings that came with the I/O settings you chose for your Speaker Station.

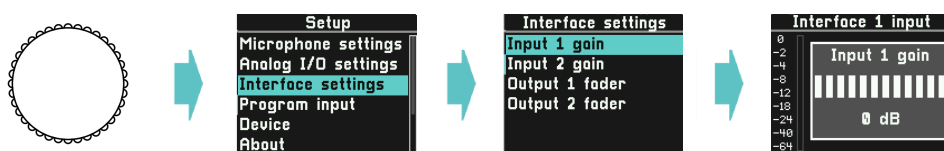

7.7.2 Interface Output Level

Adjust the fader of the backpanel interface outputs according to your needs. This overrides the settings that came with the I/O settings you chose for your Speaker Station.

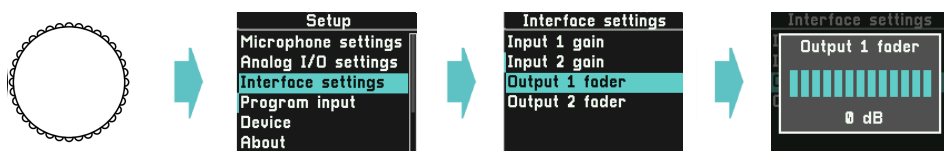

7.8 Program Input

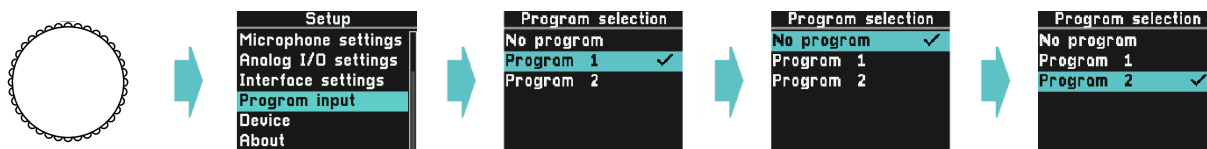

The Program inputs defined for your partyline system are listed here. You may select the Program input that suits your Role best. Selecting “No program” will switch off the Program input on your unit.

The Program volume can be controlled using the Volume button. See 6.1.9 Volume Button. 

7.9 Device



All current settings of your device are stored locally and applied again when powering up the device.

7.9.1 Reset local changes



Use this entry to revert all settings to the values as set in the active Role and I/O setting. Volumes will be set to the default values.

7.9.2 Save personal settings

This will save your personal settings to a storage space on your unit that is NOT overwritten by a firmware or a system update. Personal settings include:

Microphone settings for each gooseneck and headset:

- Microphone gain
- Microphone type
- Bandpass Filter
- VOX threshold
- VOX release time

Volume settings:

- Master output speaker
- Master output headset
- Partyline fader for channels 1 to 4
- Sidetone fader
- Program fader
- Buzzer fader

Display settings:

- Brightness
- Screensaver

Backpanel audio settings:

- Analog I/O
 - Input 1 & 2 gain
 - Output fader 1 & 2
- Interface 1 & 2
 - Input 1 & 2 gain
 - Output fader 1 & 2

Previously saved Settings will be overwritten.

7.9.3 Load personal settings



This will restore your previously saved personal settings and instantly apply them.

7.9.4 Factory reset

The unit will be reset to the factory default settings.



Please note that your device will lose connection to your active partyline system unless it is the factory default system. Use Q-Tool to add a device to a system other than the factory default system.

7.10 About

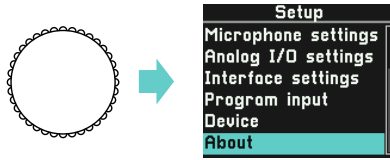

Get access to read-only information about your device. Scroll to access all available information:



7.10.1 Device name

The default name of your device is derived from the unique MAC address of your device. Use Q-Tool to name the device differently. The given name will not be changed when applying a FW update. Resetting the device to factory default condition will also reset the device name.

7.10.2 IP address

This is the current IP address of your device.

7.10.3 Firmware version

This is the current firmware version. Use Q-Tool to retrieve and apply FW updates.

7.10.4 Hardware version

This is the hardware version of your unit. This value cannot be changed.

7.10.5 MAC address

This is the MAC address of your device. This value cannot be changed.

8 Q-Tool

Get your free copy of Q-Tool, the Q-series digital partyline configuration software, to enjoy the full features of your punQtum intercom. You may download it from the punQtum website www.punQtum.com.



Please read the Q-Tool manual for more information on the configuration with Q-Tool.

9 Technical specifications

Technical specifications are in the Q210 P Speaker Station datasheet available from our website.